

MARIA TRAPICHLER – ROMAN SAUER

The Coarse Wares of Velia Fabrics and shapes

Introduction

Coarse wares comprise domestic pottery used as simple table ware, as cooking or kitchen ware or for storage of liquids and food. The greater part of the coarse wares found in Velia is made up of local products, import being reduced to special shapes like mortars or small transport vessels. In the material of the first half of the 5th c. B.C.E. Verena Gassner identified six fabrics of local production (VEL-C-1 to VEL-C-6) which was ascertained by archaeometric analysis.¹ Later on five other fabrics were distinguished by the author in course of the study of the material of contexts of pottery phase C to E (VEL-C-9 to VEL-C-13).²

The fabrics of Coarse Ware of Velia³

Macroscopic Description of Fabrics of the local production of Velia⁴

The fabrics VEL-C-1 to VEL-C-6 are arranged in order from fine to coarse. All fabrics are based on the same petrographic type, which showed four variants (RVGK0 1a-d). The macroscopic distinction was made due to differences in the texture of the fresh break (smooth to irregular), in size and frequency of inclusions, and in colors.

VEL-C-1

Samples: M1/10; M1/13; M3/10; M3/12; M3/19 (RVGK01d); M3/61 (RVGK01c)

The matrix is reddish yellow (5YR6/6), its fracture fine grained. Inclusions consist of frequent white and clear quartz and occasionally large brownish red and gray inclusions.

¹ Gassner 2003, 72.

² Gassner et al. 2014, 223-39; Trapichler 2006, 187, annex 1. Fabrics VEL-C-9 to VEL-C-13 have not yet been presented in FACEM.

³ For the detailed description of samples see Gassner and Trapichler 2011.

⁴ For a more detailed description see www.facem.at: VEL-C-1 to VEL-C-6.

VEL-C-2

Samples: M1/18; M1/23; M3/17; M3/29; M3/38; M3/39; M3/65 (RVGK01b and d)

The matrix is as the preceding fabric reddish yellow (5YR6/6), but its fracture granular. Inclusions are larger and more frequent, consisting mostly of white quartz and brownish red and gray particles, sometimes visible to the naked eye.

VEL-C-3

Samples: M1/8; M1/11; M1/15; M1/19; M1/20; M1/22 (RVGK01 and RVGK01d); M3/14; M3/66

The matrix of VEL-C-3 displays a reddish yellow color (5YR6/6) and mostly a gray core, the fracture is smooth. Inclusions are less frequent, but occasionally larger than in the preceding fabric, consisting of mostly white quartz and rarely dark gray, black and brownish red inclusions, sometimes visible to the naked eye.

VEL-C-4

Samples: M3/13; M3/15; M3/27; M3/28; M3/30; M3/73; M3/78; M3/79; M3/89 (RVGK01a)

The matrix of VEL-C-4 displays a reddish yellow color (5YR6/6), its fracture is granular to irregular. It differs from the preceding fabrics by the greater size and quantity of its inclusions, consisting to the greater part of white and clear quartz particles and rarely brownish red and dark gray or black particles, all of them occasionally visible to the naked eye.

VEL-C-5

Samples: M3/99; M3/101; M3/102 (RVGK01)

Fabric VEL-C-5 differs from the preceding fabrics by its dark brown color (7.5YR4/6), its fracture is irregular. The temper consists of partly very large white and some smaller red and reddish brown particles, which are occasionally visible to the naked eye.

VEL-C-6

Samples: M3/81 (RVGK01); M3/94; M3/96; M3/97

Fabric VEL-C-6 is of dark reddish brown (7.5YR6/4) to black color, its fracture is as the preceding fabric irregular. The temper consists of mostly white quartz particles, which are visible to the naked eye, and rarely reddish brown, brown or black particles.

VEL-C-7

Samples: M3/103

The fabric is red (2.5YR5/8), its fracture smooth. The inclusions are irregular in size and consist mostly of partly large white and clear quartz particles, occasionally visible to the naked eye, and rarely brownish red particles.

VEL-C-8

Samples: M3/105

The matrix is yellowish red (5YR5/6) to red (2.5YR5/6), its fracture smooth. It differs from the preceding fabric by the greater size and quantity of its inclusions, consisting mostly white and clear quartz particles, and rarely brownish red particles.

VEL-C-9

Samples: M3/106

The matrix is yellowish red (5YR5/6), its fracture granular. Inclusions consist of mostly white and clear quartz, sometimes visible to the naked eye, and rarely reddish brown and black particles. The fabric differs from VEL-C-2 by the occasional occurrence of white rimmed, well rounded voids, interpreted as carbonate-pseudomorphs.

VEL-C-10

Samples: M3/107

The matrix is reddish yellow (5YR6/6), the fracture is granular. It differs from the preceding fabrics by the greater quantity of its inclusions, which consist of clear and gray quartz particles, which are very frequent, and rarely white, reddish brown and black particles.

VEL-C-11

Samples: M3/104

The matrix is strong brown (7.5YR5/6), the fracture is granular. Inclusions are very frequent, consisting in mostly clear and gray quartz particles and frequent white and black, rarely reddish brown particles. The fabric differs from VEL-C-5 by the smaller size of its inclusions.

The rather fine fabric VEL-C-1 was primarily used for coarse table wares, also with banded decoration, later for jugs and *lekanai* and in general for kitchen ware which was not exposed to fire. The coarser tempered fabrics VEL-C-2 and VEL-C-3 were used for all kinds of kitchen- and cooking wares, while VEL-C-4 to VEL-C-6 were often, but not exclusively used for cooking wares. Fabrics VEL-C-7 and VEL-C-8 display great similarities to VEL-C-1, showing a comparatively fine-grained reddish yellow fracture, but are distinguished from it by the different sorting of the inclusions. These two fabrics are not common and limited to certain forms like bowls and lids. Fabric VEL-C-9 is similar to fabric VEL-C-3, but contains a discrete amount of white rimmed, rounded voids, interpreted as carbonate-pseudomorphs. It turned out to be the most important fabric in numbers from phase C onwards. Fabric VEL-C-10 is a light brown variant of VEL-C-3 and appears mostly with jugs. Fabric VEL-C-11 is in color and inclusions similar to the brown cooking ware fabric VEL-C-5, to which it differs by the size of its inclusions, which are much finer grained.

The typological development of Coarse Ware: a short overview

Phase B (470 – 400 B.C.E.)

The spectrum of the locally produced coarse ware in phase B1 (480 – 450 B.C.E.) consists of domestic pottery or common ware like jugs, storage pots, drinking vessels (*skyphoi* and one handled cups), bowls and plates.⁵ It often shows a simple banded decoration in black or reddish brown. Jugs are relatively small and show an outturned, sometimes thickened rim. Of special interest is the table ware, which seems to be limited to phase B. It consists of *skyphoi* and one-handed cups and shallow bowls with incurving rim.⁶ With their banded decoration and their elevated ring feet they resemble the characteristics of the shape in local black glaze ware. Kitchen ware is attested by mortars with thickened rim.⁷ The

⁵ See Gassner 2003, 76-101.

⁶ Gassner 2003, 6-101; 92-3, fig.38 shows the whole profile of the form.

⁷ Gassner 2003, 97, fig.41a.

spectrum of cooking ware is limited to deep globular *chytrai* with outturned rim or with a flange inside to receive a lid.⁸

Phase C (400 – 300 B.C.E. ca.)

The spectrum of locally produced coarse wares in phase C consists of domestic pottery, which comprises vessels for serving or storing liquids and bowls with different functions, kitchen ware and cooking ware. In contrast to phase B the lack of table ware forms, like *skyphoi*, bowls or plates can be minded. At the same time banded decoration becomes rare and is limited to jugs.

The numerous jugs (pl.1), which show various types of rims, can be interpreted as vessels for storage or service of liquids. Most numerous in phase C are jugs or table amphorae with various types of thickened rims which are offset from the neck, the neck running smoothly into the body (cat.1 – 2).⁹ Frequent are also jugs with outturned rim, which may be plain or furrowed (outturned rim 1 and 2), or jugs with a short projecting rim with a groove on its upper side (cat.3 – 4).¹⁰

Only few fragments of jugs with handles are preserved, the position of which might give evidence for the function of the vessel: Mostly they appear with one or two vertical handles, oval in section, and can therefore be called jug or amphora, but sometimes there are also basket handles attested (cat.3) in this case the vessels are called *situla*.¹¹ Most of the closed vessels are to be completed with disk feet and find analogies in other sites in Western Greece. Storage pots are attested with the long lasting ovoid form with a thickened, horizontal rim (cat. 11 – 12, fig.1) in phase C.¹²

Important among the shallow bowls (pl.2) are those with molded horizontal rim (cat.13 – 14), which are relative short and heavy in phase C1 and C2 and develop to more expanded

⁸ Gassner 2003, 98, fig. 42a.b.

⁹ Similar rims with cylindrical neck and two handles find analogies in table amphoras in Locri, see Barra Bagnasco 1989, 329 no.398 pl. 65; 334 nos.404-405, pl.66.

¹⁰ See for an example with globular body and one vertical handle from Locri, dating from the 5th to the 3rd c. B.C.E. Barra Bagnasco 1989, 328 no.395 pl. 50; 65.

¹¹ The form of *situla* is widespread in Southern Italy, especially on Italic sites, for analogies see Fratte: Greco et al. 1990, 150, fig. 259 no. 21 with further analogies in Laos and Capua.

¹² For analogies in Velia in a context of the second quarter of the 5th c. B.C.E., see Gassner 2003, 83 no. Ib.37; no. IIa.152 pl.7. 20 with analogies in Caulonia and Poseidonia.

and flatter forms in phase C3 (cat.15).¹³ An important type among the deep bowls of phase C is a shape with a short horizontal rim, separated from the body by a distinct ridge on the outside (cat.16). The shape is often connected with the cooking ware fabrics VEL-C-5 and VEL-C-6. For this deep shape with semi-oval body the function of a cooking bell can be suggested, in analogy with the Attic examples which are provided with a plain rim.¹⁴

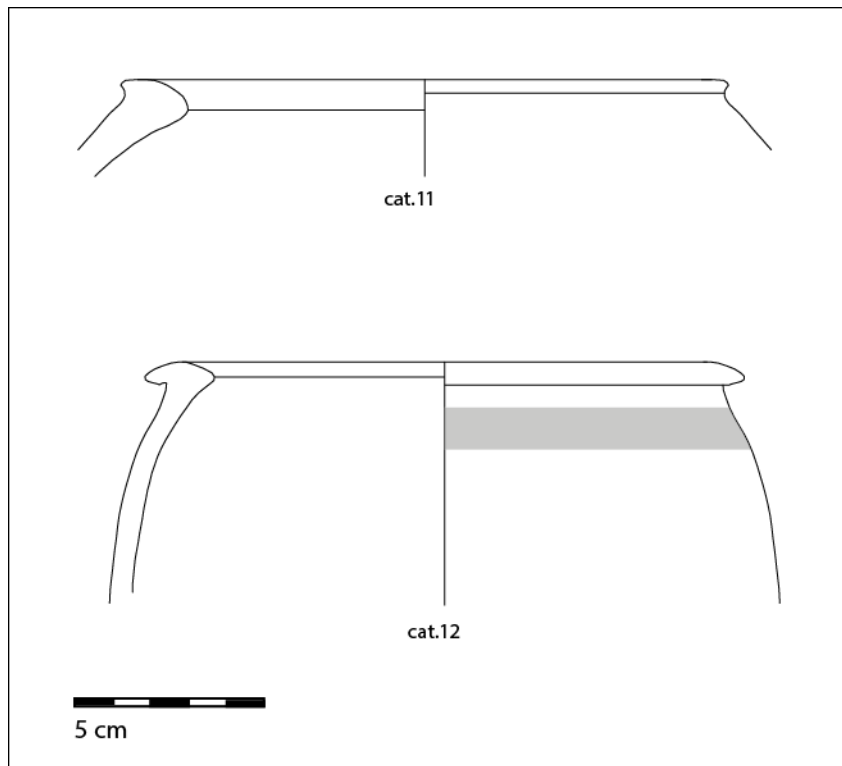

Fig.1. Velia. Coarse ware. Storage pots.

In phase C *mortaria* (pl.3) with various types of *thickened rim rounded on top* are produced locally, the long-lasting types are already attested in phase B1 at Velia (cat.22 – 23).¹⁵

The Cooking ware of phase C consists to the greater part of deep *chytrai* with continuous profile (pl.4). The simple outturned rim of the 5th c. B.C.E. disappears gradually in phase C and is replaced by a short projecting rim (cat.27 – 28). In phase C3 the continuous profile (projecting rim 1) is replaced by a conical or cylindrical neck which is separated from the

¹³ For analogies in Caulonia see: Tréziny 1989, no.202 fig. 41, *plats profonds a marli*.

¹⁴ See Sparkes and Talcott 1970, 233, no. 2021. 2022 pl. 97.

¹⁵ For analogies to thickened rim 1 in Athens see Sparkes and Talcott 1970, no. 1912 fig. 16. In Western Greece see for Locri Barra Bagnasco 1989, 296 no. 345 pl. 39; for Pomarico Vecchio see Bianco et al. 1997, pl. 66 no. 68. For analogies to thickened rim 2 in Athens see Sparkes and Talcott 1970, fig. 16 nos. 1891; 1898. For an analogy in the ship wreck of El Sec see Arribas et al. 1987, fig.3 no.6. For analogies in Western Greece, see Pomarico Vecchio: Bianco et al. 1997, pl. 66 no. 69; for Velia see Gassner 2003, 97 fig. 41.

ovoid body by an edge (projecting rim 2, cat.29).¹⁶ Deep *chytrai* with a flanged rim inside to receive a lid (pl.5) are only rarely attested in phase C1 and C2, showing mostly a simply rounded rim (flanged rim 1) or a rim which is flat on the upper side and horizontal or slightly bent inwards (flanged rim 2, cat.33). Only in phase C3 the rim form seems to be more standardized with a thickened rim, which is flat on the top (cat.34, flanged rim 3).¹⁷ The only shallow cooking form in phase C is the casserole (*lopas*) which may have convex or mostly concave walls and is provided with a more or less distinct rim with a flange inside to receive a lid (pl.6). More popular and evidently a standard shape are casseroles with concave wall (cat.38). Two rim types with flat top are attested, the type with rounded top is common from phase C3 onwards (cat.39).¹⁸ Both shapes – with convex or concave body – are provided with two attached, horizontal handles. The range of cooking forms of phase C is complemented by flat pans with heavy rims, which are often ripped on the outer side (pl.8; cat.46 – 47).

Phase D (300 – 250/40 B.C.E.)

The jugs in phase D may show a projecting rim (pl.1; cat.5 – 6) or a new characteristic rim form, which is angular and shows a ridge on the inside, perhaps to hold a lid (jug with interior flange rim 1, cat.7).¹⁹ In phase D2 jugs with rims with a molded outer surface become popular (interior flange, molded).²⁰ The rim form is also attested as *situla* with a basket handle, showing then a much lower neck (cat.8).

Among the shallow bowls (pl.2) those with projecting plain rim and semi-globular body continue in phase D (cat.17).²¹ More common are shallow bowls with horizontal rims, which are thickened on their outer end (horizontal rim 2, 3 and 4, cat.18 – 19, pl.2); these new shapes are attested with heavy, horizontal handles (cat.19).

¹⁶ See also for Locri: Barra Bagnasco 1989, 265 no. 298 pl. 36 (5th to 3rd c. B.C.E.); for Cozzo Presepe: Cotton 1977, 375 fig. 145 no. 445; for Roccalgoriosa: Gualtieri and Fracchia 1990, fig. 186, no. 251; for Poseidonia: Pontrandolfo and Rouveret 1992, 346; 430.

¹⁷ For analogies in Southern Italy see also Locri: Barra Bagnasco 1989, 268 no. 302 fig. 36.

¹⁸ The form is very common in Western Greek sites, see Locri: Barra Bagnasco 1989, 276 no. 315 pl. 37. Kaulonia: Treziny 1989, 85 fig. 59 no. 420. 426. Cozzo Presepe: Cotton 1977, 377, fig.147 no. 467. Roccalgoriosa: Gualtieri and Fracchia 1990, 263, fig. 185 no. 240. 245. 246. El Sec: Arribas et al. 1987, 517, fig. 4 no. 1 – 4; Arribas 1989, 97, fig. 2 no. 4.

¹⁹ For analogies in Southern Italy see Locri: Barra Bagnasco 1989, 331 no. 400-402 pl. 66, 5th to 3rd c. B.C.E. Pompeji: Bonghi Jovino 1984, pl. 106 no. 19. 21.

²⁰ See also Roccalgoriosa: Gualtieri and Fracchia 1990, kiln assemblage, fig. 188, no. 309; Cosa: Dyson 1976, 34 CF 76, fig. 6, *pitcher form 3*.

²¹ For analogies in Southern Italy see: Kaulonia: Treziny 1989, no. 431, fig. 60; Locri: Barra Bagnasco 1989, 300 no. 351 pl. 39; Pompeji: Bonghi Jovino 1984, 153, pl.92 no.10 CE 123.

A new type of Hellenistic mortar appears in phase D2 with a more or less thickened, downturned rim and a ridge on the inner edge as well as characteristic piecrust handles (pl.3). This form seems to be of Eastern Mediterranean origin and is soon adopted by the Western Greek productions (cat.25).²²

Among the cooking ware of phase D the deep cooking pot (*chytra*) with a short projecting rim (projecting rim 2), globular body, two horizontal and one vertical handles becomes standard (pl.2).²³ The form sees a continuous development with a more conical neck and straight profile in the beginning (phase D1), while in phase D2 the neck becomes more vertical and its profile convex (cat.30). Also the *chytrai* with a flanged rim inside to receive a lid continue in phase D (pl.5), showing a further development (rim type 3, cat.35), in phase D2 the rim is on the inside flattened and sloping downwards (rim type 4, cat.36).

In the same phase D a new type of a shallow wide-mouthed cooking pot appears (pl.7). The diameter of rim of the round bodied shape exceeds clearly the height, being at the same time deeper than the casseroles (*lopades*), which remain still in use and are characterized by their concave, out bent profile (pl.6; cat.40). Therefore possibly a different function of this new vessel form can be suggested, perhaps for stewing food (cat.43 – 44).²⁴ In phase D this new form predominates among the shallow cooking vessels. The new Hellenistic standard form of pan with low walls, concave on the outside, and rounded bottom also appears in phase D2 (cat.48, pl.8).²⁵

Phase E (late 3rd to mid of 2nd c. B.C.E.)

Phase E sees a further development of the Hellenistic forms, which appeared first in phase D. The jugs (pl.1) with angular rims and a ridge on the inside become thicker in section and may possess basket handles (cat.10) or vertical turned handles with large circular discs on top as thumb rest (cat.9).

The shallow bowls show mostly a projecting horizontal rim (type 2 and 3, cat.20 – 21, pl.2); compared to phase D the rims become wider and more edgy in detail. The mortars with

²² See also Rotroff 2006, 101 note 138, Bats 1988, 182-83; Further analogies: Roccagloriosa: Gualtieri and Fracchia 1990, 271, fig.187 no.292, with analogies in Poseidonia, Oppido Lucano und Monasterace Marina. Locri: Barra Bagnasco 1989, 296 no. 347-48, pl. 39; Kaulonia: Treziny 1989, no. 230 fig. 42.

²³ For a similar shape see Roccagloriosa: Gualtieri and Fracchia 1990, 267 no.249 fig.186.

²⁴ Analogies in Locri are denominated *lopades*: Barra Bagnasco 1989, 269 no. 305 pl. 36; Barra Bagnasco 1992, 252, pl.72 no.248; Laos : Greco et al. 1989, no. 17, pl. 19; for Velia see also Trapichler 2005; Trapichler (forthcoming).

²⁵ The shape is also attested at Locri, see Barra Bagnasco 1989, 292 no. 339 pl. 38.

downturned rim and piecrust handle stay in use and may show a thinner, lengthened lip (cat.26, pl.3).

Among the cooking vessels the percentage of the deep forms, the necked *chytra* with short projecting rim (2 and 3; cat.31 – 32, pl.4) and the deep cooking pot with lid attachment (cat.37, pl.5) become very rare in phase E. At the same time, the number of the shallow forms increases clearly. The traditional shapes, which developed out of the Greek „*batterie de cuisine*“, show particular features, similar to those of forms common in the Republican and early Imperial period,²⁶ but without the flat resting surface. The shallow forms of cooking pots develop a broad horizontal rim (cat.45, pl.7). The same feature can also be observed with a deep form of *lopades* (cat.42, pl.6), while the traditional form of casseroles in phase E (rim type 4 and 5) show straight, slightly out bent walls (cat.41, pl.6).

Also the pan with low walls, concave on the outside and one diagonal tube handle, persists in phase E (cat.49, pl.8), in contrast to the widespread later form with flat bottom it maintains a rounded bottom also in phase E.²⁷

Conclusion

As proven by the analysis of fabrics, the Coarse wares found in Velia were produced locally to a greater part. The newly attested fabrics (VEL-C-7 to VEL-C-11) from phase C onwards turned out to be variants of the earlier established fabrics (VEL-C-1 to VEL-C-6) and stem from the same raw materials,²⁸ giving very likely evidence for changes within the pottery technology or firing techniques.

The local forms find mostly analogies in other Western Greek sites. A change of form types is attested from the 3rd c. B.C.E. onwards (phase D) and can be followed to phase E (beginning of the 2nd c. B.C.E.), developing into shapes, which are characteristic in Campania and throughout Italy in Republican times.

(M. Trapichler)

²⁶ For Campania see Di Giovanni 1996; for Albintimilium see Olcese 1993; for Cosa see Dyson 1976.

²⁷ The – originally western Greek – form was adopted in Athens during the Roman period with a flat bottom, see Rotroff 2006, 188.

²⁸ For the petrographic types RVGK 1a – d see contribution by R. Sauer, *infra*.

Archeometric analyses of Velinian Coarse Ware

Introduction

Based on petrographic and heavy mineral analyses the analyzed samples of coarse ware found at Velia were divided into 12 petrographical types. It was possible to distinguish between several locally produced fabrics and imported coarse ware (fig.2 – 3).²⁹ Some more frequent fabric types have been divided further into sub types.

This report deals only with the petrographical type RVGK01 and its petrographical subtypes for which a local Velinian production is proven or very likely. The Velinian petrographical types RVGK01 to RVGK01e (11 including subtypes,) are differentiated based on slight differences in mineralogical and petrographical composition texture, grain size and degree of firing (details are given below). Common to all Velinian production is the absence or the only very rare occurrence of carbonate particles (fig.4).

The petrographic types

Following Velinian petrographic types of coarse ware have been distinguished (tab.1 – 2, fig.2):

Petrographic types RVGK01, RVGK01h and RVGK01a, RVGK01b (pl.9 – 13)

Samples: M3/2 ; M3/14; M3/15; M3/16; M3/17; M3/24; M3/25; M3/24; M3/31; M3/32; M3/35; M3/45; M3/75; M3/94; M3/97; M3/98; M3/100; M3/101 (RVGK01)
 M3/7; M3/13; M3/29; M3/30; M3/34; M3/78; M3/81; M3/89; M3/107 (RVGK01h)
 M3/27; M3/28; M3/73; M3/74; M3/96; M3/99 (RVGK01a)
 M3/38; M3/50 (RVGK01b)

Typical for RVGK01 and RVGK01a is the fine grained, weak to non-calcareous and practically non micaceous, optically active clay matrix. The fine temper content consists mainly of poorly sorted fine sand (maximum grain size: up to 2mm). A bimodal grain size distribution is also common. The total temper content (>15 μ) ranges from 10% to 35%. The temper grains consist mainly of monocrystalline quartz grains, followed by feldspars, dominating is K-

²⁹ Overview graphs on the various common ware fabrics analyzed at Velia show the differences in mineralogical-petrographic composition between local and imported common ware; see also Gassner and Sauer 2002.

feldspar (partially sericitised). Sanidine and plagioclase (partially of volcanic origin) occur also rarely. Brownish iron oxide concretions (predominantly iron oxide cemented clay pellets and silt grains), opaque grains, polycrystalline quartz, muscovite, heavy minerals (partially clinopyroxene grains), crystalline rock fragments (mainly quartzite, rare mica schist), sand and siltstone particles, volcanic rock fragments and chert also occur subordinate. Only occasionally volcanic tuff, volcanic glass, biotite, shale fragments or siliceous bioclasts could be found. The brownish concretions represent probably weathering residue derived from paleosols.

The heavy mineral composition is characterized by variable high, but dominating clinopyroxene contents and also abundant brookite/anatase and zircon. Subordinate garnet, rutile, hornblende/amphibole and traces of tourmaline, epidote/zoisite/clinozoisite and glaucophane can be detected. Only in one sample neofomed calcite could be found within elongated pores (M3/75).

Interpretation

Likely the used raw materials have been derived from terrace sediments especially from paleosols developed on top of altered tuffitic layers. The clays are mixed with altered pyroclastic particles, but show still relatively low contents of hornblende/amphibole. Similar paleosols could be frequently observed e. g. in cores of shallow wells drilled in different parts of the excavation site (wells B4, B5, B6, B7 (1992)³⁰ and also in newer unpublished wells (1994): e. g. S 35, S 36 (Vignale, fig.5).

Petrographic type RVGK01h is distinguished from petrographic type RVGK01 mainly by its optically inactive groundmass, but the mineralogical composition in general is very similar. The temper grains are sometimes partly very coarse grained and are bimodal to poorly sorted. Partially coarse grained flysch rock components, silica cemented siltstone/sandstone fragments and vein quartz can be observed. RVGK01h therefore can be considered as a slightly higher fired variant of RVGK01.

Petrographic type RVGK01a is distinguished from petrographic types RVGK01, and RVG01h mainly by the heavy mineral content. It is characterized by reduced clinopyroxene contents

³⁰ See cross section with the wells in Sauer 1999, 117-24, fig. 10.

but higher proportions of hornblende/amphibole. Also typical are, partly very frequent, brownish reddish iron oxide agglomerates, and partly pyroclastic material (volcanic rock or tuff fragments, sanidine, etc.). Some silty iron oxide concretions show partly a concentric texture.

The utilized raw materials are probably paleosols mixed with weathered, strongly altered, amphibole bearing tuffites. Similar altered amphibole bearing, pyroclastic layers were also sometimes observed intercalated in cores of terrace sediments of wells located especially in the area of Vignale (wells mentioned above).

Petrographic type RVGK01b is distinguished by its lower and fine grained temper content. Typical is the heavy mineral assemblage with especially high contents of hornblende/amphibole and augite.

Apparently weakly weathered, tuffitic paleosols have been used for its production. Such raw materials have been observed in wells, but also in surface outcrops near the excavation site.

Petrographic type RVGK01c, RVGK01c1 (pl.14 – 16)

Samples: M1/3; M3/26; M3/33; M3/56; M3/79; M3/102; M3/103; M3/104; M3/106;

Petrographic fabric type RVGK01c is characterized mainly by the slightly mica bearing, silty groundmass and also by a higher content of coarse grained muscovite. The heavy mineral residues are characterized by lower values of hornblende/amphibole and increased clinopyroxene contents. Only sample M3/102 (RVGK01c1) contains occasionally particles of calcite and calcareous sandstone.

Interpretation

The utilized ceramic raw material probably is a mixture of terrace loam and paleosol. Similar sediments have been found, in many cores of the pleistocene terrace sediments, penetrated by many wells, located within or outside of the excavation site. RVGK01c is sometimes difficult to define as similarities to both RVGK01 and RVGK01d exist.

Petrographic types RVGK01d, RVGK01d1s, RVGK01d2, RVGK01dh (pl.17 – 19)

Samples: M1/1 ; M1/4; M1/8; M1/9; M1/10; M1/11; M1/12; M1/13; M1/15; M1/18; M1/22; M1/23; M3/5; M3/10; M3/12; M3/19; M3/22; M3/23; M3/37; M3/39; M3/44; M3/46; M3/47; M3/48; M3/61; M3/66; M3/105 (RVGK01d)

M1/2; M1/14; M1/19; M1/21 (RVGK01d1)

M1/20; M1/24; M1/25; M3/9; M3/42; M3/43 (RVGK01d2)

M1/7; M1/16; M1/17; M3/40 (RVGK01dh-s)

Petrographic type RVGK01d is the most frequently occurring petrographic type (25 samples). Typical is the significant mica (muscovite) content and the absence of carbonate particles. The average temper content of the analyzed samples is 15% (6 – 20%). The non-calcareous, micaceous, optically active to inactive groundmass shows some mica and an increased siliciclastic silt content. The temper particles show a very poor to bimodal sorting (maximum grain size partly up to 5 mm). Partially also a bimodal grain size distribution can be observed. The temper grains consist mainly of monocrystalline quartz grains, followed by feldspar and muscovite. Among the feldspars K-feldspar (partly sericitised) is dominating, subordinate also sanidine and rare plagioclase (partly of volcanic origin) can be found. Further temper grains are brown iron oxide concretions and opaque grains, polycrystalline quartz, heavy minerals (partly clinopyroxene grains), crystalline rock fragments (mainly quartzite, rare quartz-mica and quartz-feldspar aggregates), sand/siltstone grains, biotite, volcanic rock fragments, shale fragments and chert. Only traces of siliceous bioclasts could be found. Only in two samples traces of possible carbonate grains could be found (M3/37, M3/48).

The heavy mineral composition is characterized mainly by clinopyroxene, zircon and brookite/anatase dominances. Subordinate also garnet, rutile, hornblende/amphibole and traces of tourmaline, epidote/zoisite/clinozoisite and glaucophane are present.

Due to slight textural and petrographic differences the petrographic fabric RVGK01d can be further subdivided into subfabrics. Petrographic type RVGK01d1 is distinguished by the frequent occurrence of partly rounded Flysch components (claystone and silica cemented siltstone/sandstone fragments, quartzite). Petrographic type RVGK01d2 shows a low temper content between 7 – 10%, but a significant higher occurrence of mica, mica being the most

frequent temper mineral. Petrographic type RVGK01dh-s: these samples are highly fired samples or even partly overfired samples (slag) of the fabric type RVGK01d. The samples contain frequently vitrified temper particles and exhibit roundish pores.

Interpretation

The local raw materials for the petrographic type RVGK01d can be found predominately within the terrace sediments and partly alluvial deposits. Minor differences in mica content, grain size and the proportion of flysch rock material point to slightly variable sources (possibly different clay pits). Practically for all fabric types suitable raw materials can be found in the near surroundings of the excavation site (for example also in the recent clay pits near Casal Velino). Only the mica rich clay of petrographic fabric RVGK01d2 could still not be found, up to now.

Petrographic type RVGK01e

Sample: M3/80

This type is characterized by a relatively fine grained groundmass, which is artificially tempered with sand (strongly bimodal grain size distribution). The sand composition is similar to local sands.

Interpretation

Most likely, an artificial, with sand tempered, reworked local clay from the area of the flysch zone has been used for production.

(R. Sauer)

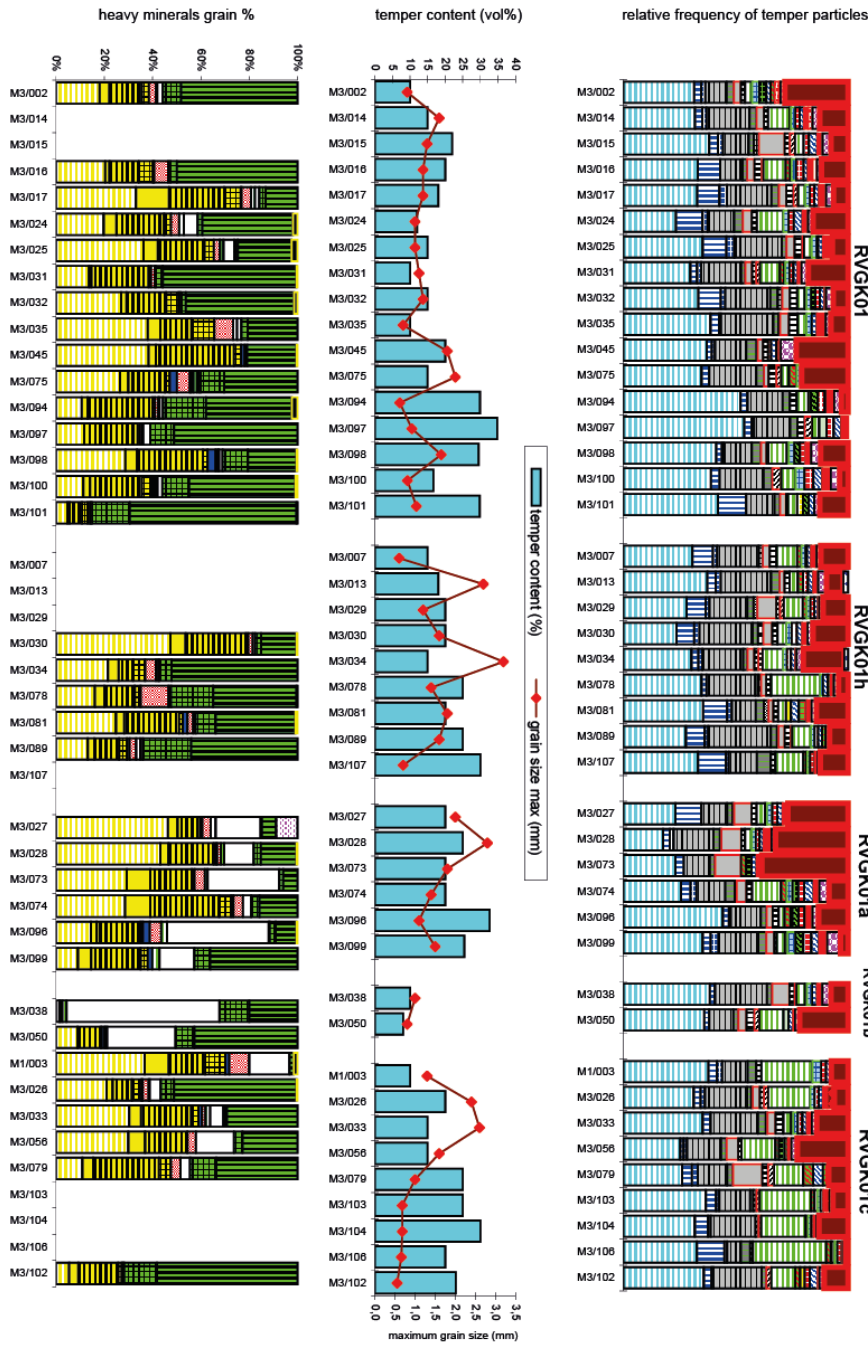

Legend: Composition of temper grains

- | | |
|---------------------------------------------|----------------------------------------|
| monocrystalline quartz | polycrystalline quartz |
| chert | K-feldspar |
| K-feldspar sericitised | microcline |
| perthite | sanidine |
| plagioclase | volcanic plagioclase |
| muscovite | biotite/oxidised sheed silicates |
| carbonate grains | molds of former carbonates |
| foraminifera | carbonate bioclasts |
| siliceous bioclasts | siltstone/sandstone fragments |
| shale fragments | clay nodules (not resolved clay paste) |
| crystalline rock fragments | quartzite |
| mica schist | other metamorphic lithic fragments |
| volcanic rock fragments | volcanic tuff |
| volcanic glass (brown) | volcanic glass (colourless) |
| heavy minerals | iron oxide concretions |
| overfired, vitrified grains, slag particles | |

Legend: Heavy mineral analyses

- | | | |
|-----------------------|---------------------|------------------------------|
| zircon | rutile | brookite/anatase |
| titanite | tourmaline | garnet |
| staurolite | kyanite | epidote/zoisite/clinozoisite |
| hornblende | chloritoid | andalusite |
| chromian spinel | sillimanite | clinopyroxene(diopsidic) |
| clinopyroxene (green) | ? oxidised pyroxene | grains not identified |
| melanite/spinel | | |

Fig.2. Velia. Coarse ware. Petrographic types.

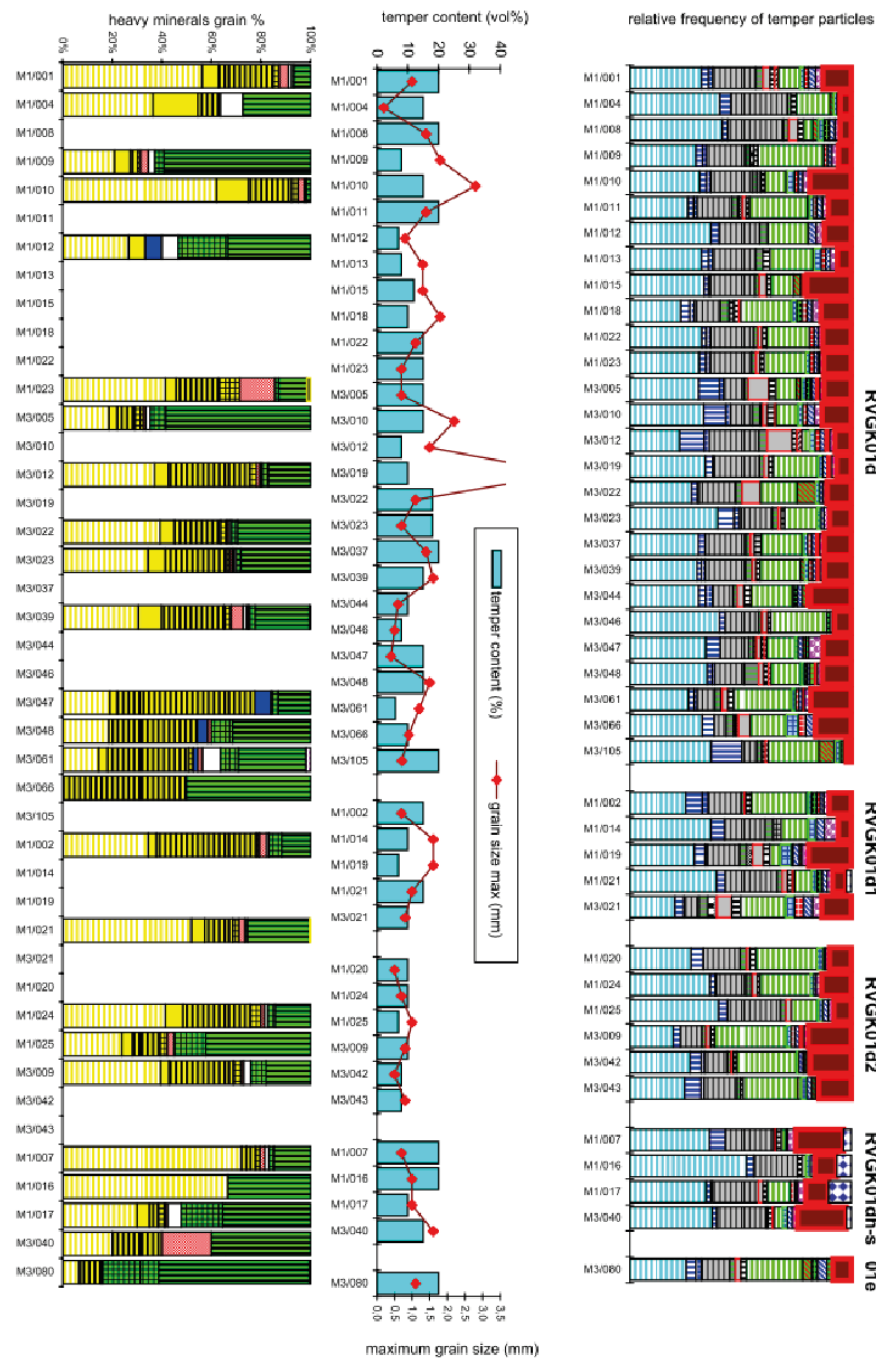

Legend: Composition of temper grains

- | | |
|---------------------------------------------|----------------------------------------|
| monocrystalline quartz | polycrystalline quartz |
| chert | K-feldspar |
| K-feldspar sericitised | microcline |
| perthite | sanidine |
| plagioclase | volcanic plagioclase |
| muscovite | biotite/oxidised sheed silicates |
| carbonate grains | molds of former carbonates |
| foraminifera | carbonate bioclasts |
| siliceous bioclasts | siltstone/sandstone fragments |
| shale fragments | clay nodules (not resolved clay paste) |
| crystalline rock fragments | quartzite |
| mica schist | other metamorphic lithic fragments |
| volcanic rock fragments | volcanic tuff |
| volcanic glass (brown) | volcanic glass (colourless) |
| heavy minerals | iron oxide concretions |
| overfired, vitrified grains, slag particles | |

Legend: Heavy mineral analyses

- | | | |
|-----------------------|---------------------|------------------------------|
| zircon | rutile | brookite/anatase |
| titanite | tourmaline | garnet |
| staurolite | kyanite | epidote/zoisite/clinozoisite |
| hornblende | chloritoide | andalusite |
| chromian spinel | sillimanite | clinopyroxene(diopsidic) |
| clinopyroxene (green) | ? oxidised pyroxene | grains not identified |
| melanite/spinel | | |

Fig.3. Vela. Coarse ware. Petrographic types.

Comparison of petrographical composition between local Velinian and imported Common Ware

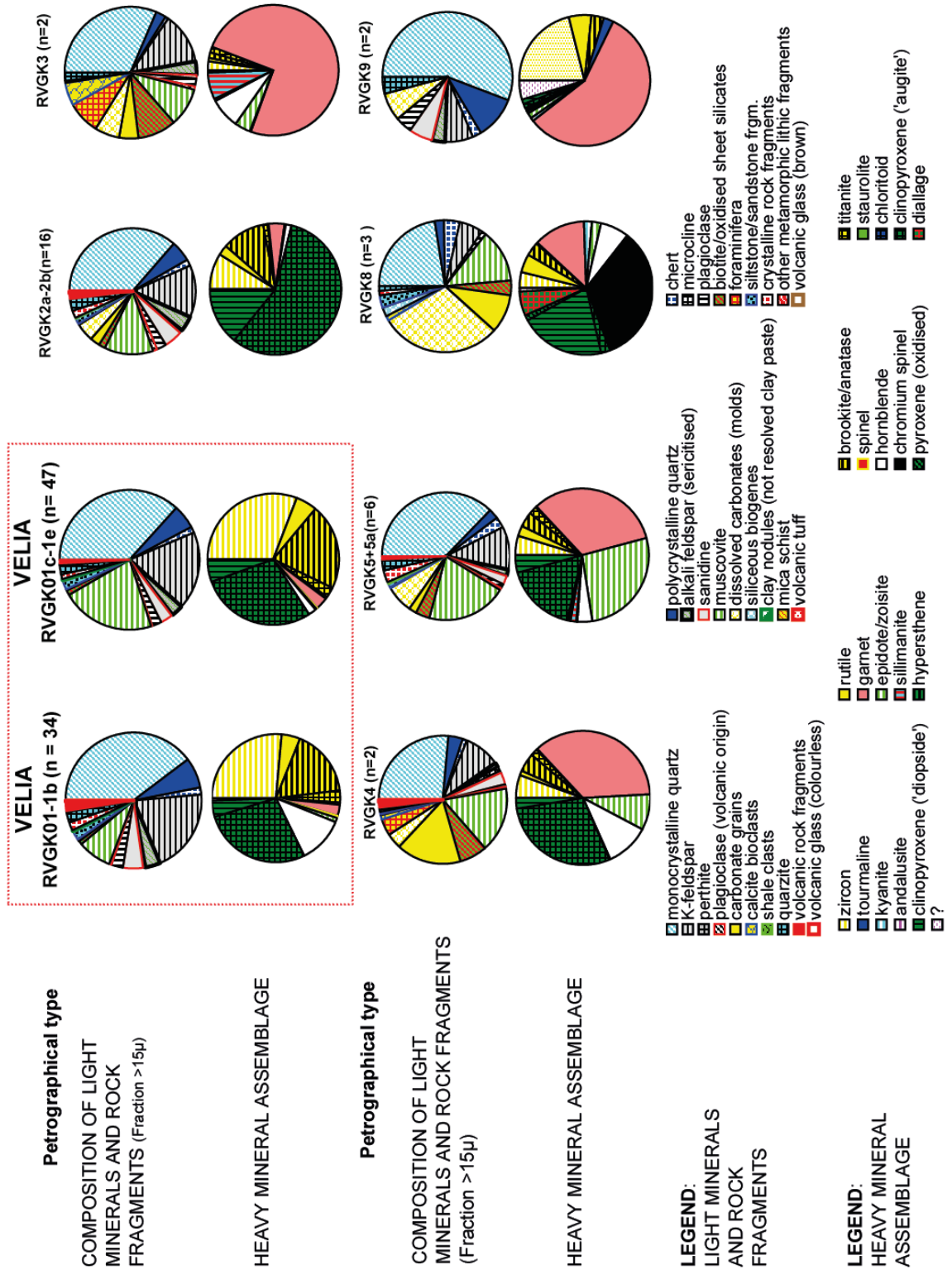

Fig.4. Comparison of petrographical composition between local Velinian and imported Common Ware.

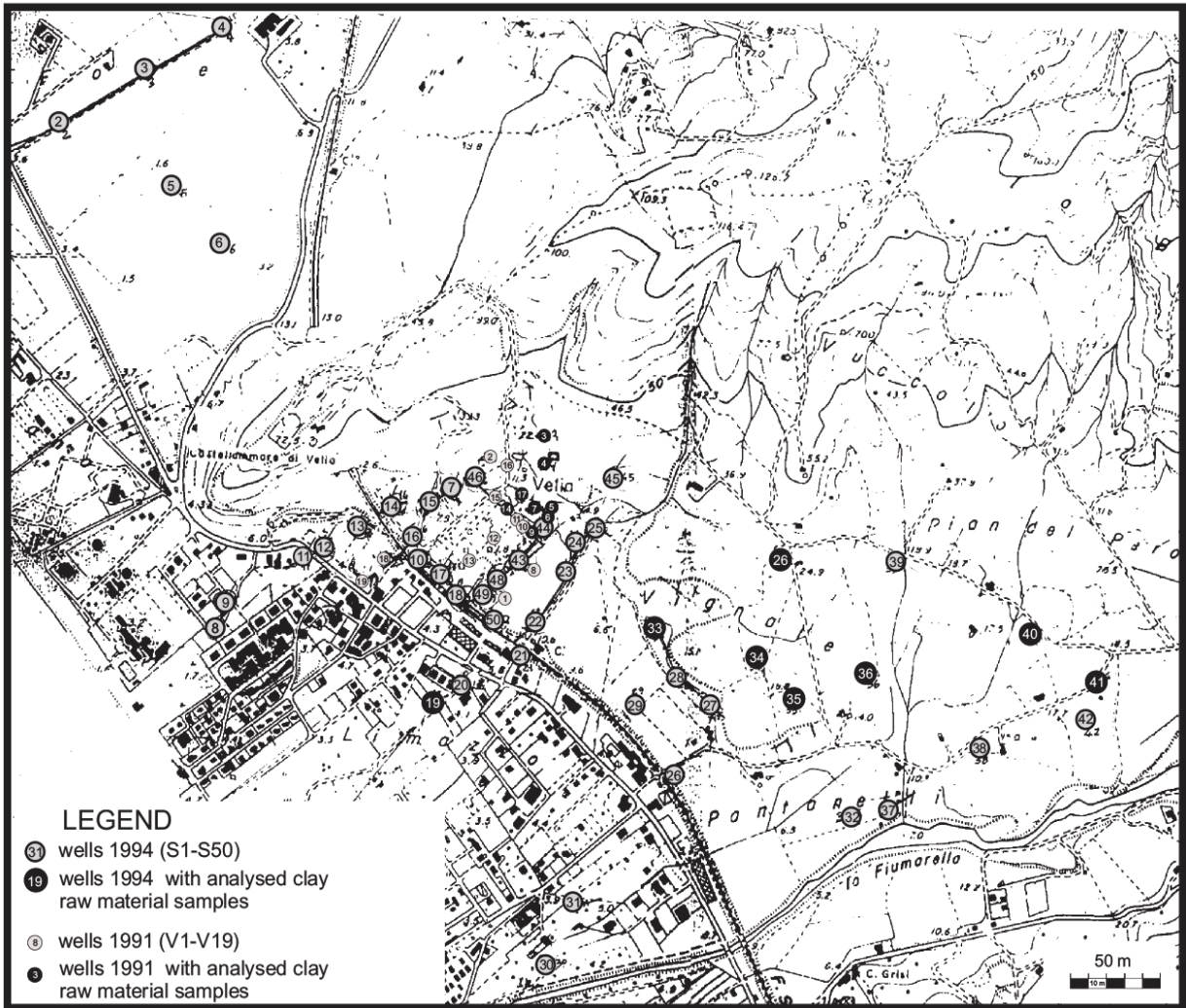

Fig.5. Location of drill cores in Velia.

Catalogue

- Cat. 1. (pl.1). Jug. Thickened rim 1. Traces of white slip. VEL-C-9. Eastern quarter, crossroad D3, 10074/97-11. Pottery phase C 1 (400-370/60 B.C.E.)
- Cat. 2. (pl.1). Jug. Thickened rim 1. Smoothed. VEL-C-1. Eastern quarter, crossroad D3, 10.061/97-41. Pottery phase C 1 (400-370/60 B.C.E.)
- Cat. 3. (pl.1). Jug. Projecting rim, thickened. Smoothed. VEL-C-1. Eastern quarter, crossroad D3, 10.061/97-45. Pottery phase C 1 (400-370/60 B.C.E.)
- Cat. 4. (pl.1). Jug (situla). Projecting rim, thickened. Basket handle. Coarse. VEL-C-2. Eastern quarter, crossroad D3, 10.068/97-13. Pottery phase C 1 (400-370/60 B.C.E.)
- Cat. 5. (pl.1). Jug. Projecting rim 1. Handle oval in section. Smoothed. VEL-C-10. Lower Town, Fortification, wall B, 209/97-320. Pottery phase D 1 (300-275 B.C.E.)
- Cat. 6. (pl.1). Jug. Projecting rim 1. Light brown, Smoothed. VEL-C-3. Acropolis, Pozzo I, fill. PI/77-1007. Pottery phase D 2 (275-250 B.C.E.)
- Cat. 7. (pl.1). Jug. Interior Flange 1. Reddish yellow. Coarse. VEL-C-9. Acropolis, Pozzo I, fill, PI/77-1020. Pottery phase D 2 (275-250 B.C.E.)
- Cat. 8. (pl.1). Jug. Interior flange, molded. Basket handle. Pink, coarse. VEL-C-9. Acropolis, Pozzo I, fill, PI/77-1008. Pottery phase D 2 (275-250 B.C.E.)
- Cat. 9. (pl.1). Jug. Interior flange. Torn handle. VEL-C-3. Lower Town, Fortification, wall B, 512/2/98-37. Pottery phase E (225-175/150 B.C.E.)
- Cat. 10. (pl.1). Jug. Interior flange. Basket handle. Smoothed. VEL-C-9. Lower Town, Fortification, wall B, 525/3/98-39. Pottery phase E (225-175/150 B.C.E.)
- Cat. 11. (fig.1). Storage pot. Thickened rim. Rim red slipped. On shoulder: painted wavy line. Smoothed. VEL-C-3. Eastern quarter, Crossroad D3, 10.058/97-26. Pottery phase C 1 (400-370/60 B.C.E.)
- Cat. 12. (fig.1). Storage pot. Thickened rim. Smoothed. VEL-C-2. Lower Town, Fortification, wall B, 216/99-70. Pottery phase C 3 (330-300 B.C.E.)
- Cat. 13. (pl.2). Bowl (Lekane). Projecting rim 1. Pinkish light brown, smoothed. VEL-C-5. Eastern quarter, Crossroad D3, 10.022/97-11. Pottery phase C 1 (400-370/60 B.C.E.)

- Cat. 14. (pl.2). Bowl (Lekane). Projecting rim 1. Horizontal handles, round in section. Light brown, smoothed. VEL-C-5. Eastern quarter, Crossroad D3, 10.054/97-21. Pottery phase C 2 (370/60-330 B.C.E.)
- Cat. 15. (pl.2). Bowl (Lekane). Projecting rim. Light red slipped. VEL-C-3. Eastern quarter, Crossroad D3, 10.017/97-13. Pottery phase C 3 (330-300 B.C.E.)
- Cat. 16. (pl.2). Deep bowl. Projecting rim. Ridge outside. Dark brown, coarse, fire darkened. VEL-C-6. Eastern quarter, Crossroad D3, 10.060/97-26. Pottery phase C 2 (370/60-330 B.C.E.)
- Cat. 17. (pl.2). Bowl (Lekane). Projecting rim 4. Reddish yellow, coarse. VEL-C-3. Lower Town, Fortification, wall B, 211/99-36. Pottery phase D 1 (300-275 B.C.E.)
- Cat. 18. (pl.2). Bowl (Lekane). Projecting rim 2. Coarse. VEL-C-3. Lower Town, Fortification, wall B, 205/97-97. Pottery phase D 1 (300-275 B.C.E.)
- Cat. 19. (pl.2). Bowl (Lekane). Projecting rim 3. Horizontal handle, round in section, thumb rest. VEL-C-3. Lower Town, Fortification, wall B, 209/99-275. Pottery phase D 2 (275-250 B.C.E.)
- Cat. 20. (pl.2). Bowl (Lekane). Projecting rim 2. Coarse. VEL-C-8. Lower Town, Fortification, wall B, 533/4/98-11. Pottery phase E (225-175/150 B.C.E.)
- Cat. 21. (pl.2). Bowl (Lekane). Projecting rim 3. Coarse. VEL-C-6. Lower Town, Fortification, wall B, 525/1/98-75. Pottery phase E (225-175/150 B.C.E.)
- Cat. 22. (pl.3). Mortar. Thickened rim 1. Reddish yellow, coarse. VEL-C-3. Eastern quarter, crossroad D3, 10.021/97-21. Pottery phase C 1 (400-370/60 B.C.E.)
- Cat. 23. (pl.3). Mortar. Thickened rim, rounded on top. Outside light brown, smoothed. Inner surface with small pebbles. VEL-C-3. Eastern quarter, Crossroad D3, 10.020/97-96. Pottery phase C 2 (370/60-330 B.C.E.)
- Cat. 24. (pl.3). Mortar. Thickened rim 2. Reddish yellow, coarse. VEL-C-3. Lower Town, Fortification, wall B, 216/99-85. Pottery phase C 3 (330-300 B.C.E.)
- Cat. 25. (pl.3). Mortar. Downturned rim with ridge at inner edge. Piecrust handles. Coarse. VEL-C-3. Lower Town, Fortification, wall B, 209/99-541. Pottery phase D 2 (275-250 B.C.E.)
- Cat. 26. (pl.3). Mortar. Downturned rim with ridge at inner edge 3. Piecrust handles. Coarse. VEL-C-10. Lower Town, Fortification, wall B, 519/1/98-34. Pottery phase E (225-175/150 B.C.E.)

- Cat. 27. (pl.4). Chytra. Projecting rim 1. Smoothed, fire darkened. VEL-C-3. Eastern quarter, Crossroad D3, 10.020/97-105. Pottery phase C 2 (370/60-330 B.C.E.)
- Cat. 28. (pl.4). Chytra. Short, projecting rim. Smoothed. VEL-C-6. Lower Town, Fortification, wall B, 216/99-77. Pottery phase C 3 (330-300 B.C.E.)
- Cat. 29. (pl.4). Chytra. Short, projecting rim 1. Light brown. Rim fire darkened. VEL-C-6. Eastern quarter, Crossroad D3, 10.017/97-7. C 3 (330-300 B.C.E.)
- Cat. 30. (pl.4). Chytra. Short, projecting rim. Coarse. VEL-C-9. Lower Town, Fortification, wall B, 209/99-166. Pottery phase D 2 (275-250 B.C.E.)
- Cat. 31. (pl.4). Chytra. Short, projecting rim 2. Reddish yellow to gray, coarse. VEL-C-9. Lower Town, Fortification, wall B, 512/3/98-29. Pottery phase E (225-175/150 B.C.E.)
- Cat. 32. (pl.4). Chytra. Short, projecting rim 3. Outside: Reddish gray, inside reddish brown. VEL-C-8. Lower Town, Fortification, wall B, 525/3/98-99. Pottery phase E (225-175/150 B.C.E.)
- Cat. 33. (pl.5). Chytra. Rim with interior flange 2. Light brown, coarse. VEL-C-5. Eastern quarter, Crossroad D3, 10.011/97-31. Pottery phase C 2 (370/60-330 B.C.E.)
- Cat. 34. (pl.5). Chytra. Rim with interior flange 3. Coarse. VEL-C-5. Eastern quarter, Crossroad D3, 10.015/97-72. Pottery phase C 3 (330-300 B.C.E.)
- Cat. 35. (pl.5). Chytra. Rim with interior flange 3. Light brown, coarse, fire darkened. Vertical handles, broken. VEL-C-11. Acropolis, Pozzo I, fill, PI/77-1015. Pottery phase D 2 (275-250 B.C.E.)
- Cat. 36. (pl.5). Chytra. Rim with interior flange 4. Coarse. VEL-C-3. Lower Town, Fortification, wall B, 209/99-183. Pottery phase D 2 (275-250 B.C.E.)
- Cat. 37. (pl.5). Chytra. Rim with interior flange 3. Coarse. VEL-C-2. Lower Town, Fortification, wall B, 703/97-79. Pottery phase E (225-175/150 B.C.E.)
- Cat. 38. (pl.6). Lopas. Concave wall 1. Coarse. VEL-C-6. Eastern quarter, crossroad D3, 10.020/97-110. Pottery phase C 2 (370/60-330 B.C.E.)
- Cat. 39. (pl.6). Lopas. Concave wall 1. Light red, smoothed. VEL-C-3. Eastern quarter, crossroad D3, 10.017/97-12. Pottery phase C 3 (330-300 B.C.E.)
- Cat. 40. (pl.6). Lopas. Concave wall 1. Light red, smoothed. VEL-C-9. Acropolis, Pozzo I, fill, PI/77-1045. Pottery phase D 2 (275-250 B.C.E.)

- Cat. 41. (pl.6). Lopas. Horizontal projecting rim. Coarse. VEL-C-8. Lower Town, Fortification, wall B, 531/1/98-29. Pottery phase E (225-175/150 B.C.E.)
- Cat. 42. (pl.6). Lopas. Horizontal projecting rim. Coarse. VEL-C-9. Lower Town, Fortification, wall B, 703/97-66. Pottery phase E (225-175/150 B.C.E.)
- Cat. 43. (pl.6). Shallow cooking pot. Rim with interior flange 1. Coarse. VEL-C-4. Lower Town, Fortification, wall B, 211/99-43. Pottery phase D 2 (275-250 B.C.E.)
- Cat. 44. (pl.6). Shallow cooking pot. Rim with Interior Flange 2. Horizontal handle, round in section. Coarse, fire darkened. VEL-C-3. Lower Town, Fortification, wall B, 209/99-573. Pottery phase D 2 (275-250 B.C.E.)
- Cat. 45. (pl.7). Shallow cooking pot. Projecting rim. Coarse, gray outside. VEL-C-3. Lower Town, Fortification, wall B, 524/1/98-19. Pottery phase E (225-175/150 B.C.E.)
- Cat. 46. (pl.7). Pan. Thickened rim. Coarse, fire darkened. VEL-C-11. Vignale, crossroad D3, 10.058/97-37. Pottery phase C 1 (400-370/60 B.C.E.)
- Cat. 47. (pl.7). Pan. Thickened rim. Loop handle. Coarse, fire darkened. VEL-C-11. Eastern quarter, Crossroad D3, 10.019/97-47.48. Pottery phase C 2 (370/60-330 B.C.E.)
- Cat. 48. (pl.7). Pan. Carinated wall 1. Coarse, fire darkened. VEL-C-1. Lower Town, Fortification, wall B, 209/99-300. Pottery phase D 2 (275-250 B.C.E.)
- Cat. 49. (pl.7). Pan. Carinated wall 1. Tubular handle. Coarse, fire darkened. VEL-C-11. Lower Town, Fortification, wall B, 520/4/98-59. Pottery phase E (225-175/150 B.C.E.)

References

- Arribas A., M. Trias, D. Cerda, and J. De La Hoz. 1987. *El barco de El Sec. Estudio de los materiales*. Mallorca: Graficas Miramar.
- Arribas, A. 1989. "El Sec. Cerámica común, bronce, molinos, varia." In *Greco et Ibères au IV siècle avant Jésus-Christ. Commerce et iconographie. Table Ronde Bordeaux 16 – 18 décembre 1986*, edited by P. Rouillard – M. Chr. Villanueva-Puig, 93-116. *REA* 89,3. Paris: de Boccard.
- Barra Bagnasco, M. 1989. *Locri Epizefiri III, Cultura materiale e vita quotidiana*. Studi e materiali di archeologia 2. Firenze: Casa Editrice Le Lettere.

- Barra Bagnasco, M. 1992. *Locri Epizefiri IV, Lo scavo di Marasa sud. Il sacello tardo arcaico e la "casa dei leoni". Studi e materiali di archeologia 4.* Firenze: Casa Editrice Le Lettere.
- Bats, M. 1988. *Vaisselle et alimentation à Olbia en Provence (v. 350–v.50 av. J.-C.). RANarb Suppl. 18.* Paris: Editions du Centre national de la recherche scientifique.
- Bianco, O., A. Deodato, and M.C. Marchegiani. 1997. "La ceramica comune." In *Pomarico Vecchio 1. Abitato. Mura. Necropoli. Materiali*, edited by M. Barra Bagnasco, 175-99. Quaderni di archeologia e storia antica 10. Galatina: Congedo.
- Bonghi Jovino, M. 1984. *Ricerche a Pompei. L'insula V della regio VI dalle origine al 79 d.C.*, Rome: "L'Erma" di Bretschneider.
- Cotton, M.A. 1977. "Coarse Wares." In *The excavations at Cozzo Presepe, 1969 – 1972*, edited by L. Du Plat, J. Taylor, E. MacNamara and J. Ward-Perkins, 364-79. *NSc 31 Suppl.*
- Di Giovanni, V. 1996. "Produzione e consumo di ceramica di cucina nella Campania romana (II a. C. – II d.C.)" In *Les céramiques communes de Campanie et de Narbonnaise (Ier s. av. J.-C. - IIe s. ap. J.-C.): la vaisselle de cuisine et de table, Actes des journées d'étude organisées par le Centre J. Bérard, Naples, 27 - 28 mai 1994*, edited by M. Bats, 65-103. Naples: Centre Jean Bérard.
- Dyson, S.L. 1976. *Cosa, The Utilitarian Pottery.* *Memoirs of the American Academy in Rome 33.* Rome: American Academy in Rome.
- Gassner, V. 2003. *Materielle Kultur und kulturelle Identität in Elea in spätarchaisch-frühklassischer Zeit. Untersuchungen zur Gefäss- und Baukeramik aus der Unterstadt (Grabungen 1987-1993).* *Velia Studien 2.* Wien: Verl. der Österr. Akad. der Wiss.
- Gassner, V., and R. Sauer. 2002. "Archaeometrical characterisation and provenance studies on pottery found at Velia (Southern Italy)" In *Archaeometry 98: Proceedings of the 31st International Symposium, Budapest, April 26 – May 3, 1998*, edited by E. Jerem and K.T. Biro, 547-54. *BARIntSer. 1043 (II).* Oxford: Archaeopress.
- Gassner, V., and M. Trapichler. 2011. "Fabrics of Velia." FACEM.
http://facem.at/img/pdf/Fabrics_of_Velia_05_06_2011.pdf.
- Greco, G., S. Luppino, and A. Schnapp. 1989. "Laos I, Scavi a Marcellina 1973 – 1985." *Magna Graecia 5.* Taranto: Istituto per la storia e l'archeologia della Magna Grecia.
- Greco, G., A. Pontrandolfo and A. Rouveret. 1990. *Fratte: un insediamento etrusco-campano.* Modena: Panini.
- Gualtieri, R., and H. Frachia. 1990. *Roccagloriosa I. L'abitato: scavo e ricognizione topografica.* Naples: Centre Jean Bérard.

- Olcese, G. 1993. *Le Ceramiche Comuni di Albintimilium. Indagine archeologica e archeometria sui materiali dell'area del Cardine*. Firenze: All'Insegna del Giglio.
- Pontrandolfo, A., and A. Rouveret. 1992. *Le tombe dipinte di Paestum*. Modena: Panini.
- Rotroff, S. 2006. *Hellenistic Pottery. The Plain Wares*. The Athenian Agora 33. Princeton, N.J.: American School of Classical Studies at Athens.
- Sauer, R. 1999. "Sedimente und Sedimentationsgeschichte in der Unterstadt von Velia." In *Neue Forschungen in Velia. Akten des Kongresses "La ricerca archeologica a Velia", Rom, 1.-2. Juli 1993*, edited by F. Krinzinger and G. Tocco, 117-24. Velia Studien I, Archäologische Forschungen 2. Wien: Verlag der Österreichischen Akademie der Wissenschaften.
- Sparkes, B., and L. Talcott. 1970. *Black and Plain Pottery of the 6th and 5th century B.C.* The Athenian Agora XII. Princeton, N.J.: American School of Classical Studies at Athens.
- Trapichler, M. 2005. "Chytra, Kakkabos, Lopas, Tagenon. Zur Entwicklungsgeschichte velinischer Kochtöpfe von spätarchaischer bis in hellenistische Zeit." In *Synergia, Vol 2, Festschrift für Friedrich Krinzinger*, edited by B. Brandt, V. Gassner and S. Ladstätter, 69-76. Wien: Phoibos-Verl.
- . 2006. "Kontinuität und Veränderung. Studien zur Keramik spätklassischer und hellenistischer Zeit aus Velia." Ph.D.diss., Vienna University.
- . Forthcoming. "Kochtöpfe als Kulturindikatoren? Zu Form und Funktion von Kochtöpfen der griechischen Stadt Velia im westlichen Lukanien zwischen 400 und 200 v. Chr." In *Fabrications et fonctions: les cultures en contact et la céramique commune*, edited by P. Rouillard. Nanterre: Publications de la Maison de l'Archéologie e de l' ethnologie de Nanterre.
- Treziny, H. 1989. *Kaulonia I. Sondages sur la fortification nord 1982 – 1985*. Cahiers du Centre Jean Bérard 13. Naples: Centre Jean Bérard.

Annex 1: list of samples analyzed by thin section and heavy mineral analysis

Reference sample in bold letters

Fabric	Petr. Type	No. of Sample	Reg. No.	Form/Description	Context	Pottery phase
VEL-C-1	RVGK01 d	M3/10	25/90-33	Jug, fragment of rim. Reddish yellow, coarse.	Lower Town; Crossroad	B 3
VEL-C-1	RVGK01 d	M3/12	24/90	Jug, handle. Reddish yellow, coarse.	Lower Town; Crossroad	B 2
VEL-C-1	RVGK01 d	M3/19	26/90	Closed vessel, body fragment	Lower Town; Crossroad	B 2
VEL-C-1	RVGK01 c	M3/61	80/88	Closed vessel, body fragment	Insula II, Late Archaic mud brick houses	B 1
VEL-C-1	RVGK01 d	M1/10	26/90	Crater, body fragment	Lower Town; Crossroad	B 1
VEL-C-1	RVGK01 d	M1/13	28/90	Lekane. Horizontal, projecting rim.	Lower Town; Crossroad	B 1
VEL-C-2	RVGK01	M3/17	27/90	Chytra. Outturned rim. Coarse, reddish yellow	Lower Town; Crossroad	B 2
VEL-C-2	RVGK01 d3	M3/29	24/90-25	Mortar, rim. Coarse.	Lower Town; Crossroad	B 3
VEL-C-2	RVGK01 b	M3/38	23a/90-38	Casserole, rim. Coarse.	Lower Town; Crossroad	B 3
VEL-C-2	RVGK01 d	M3/39	-	Pot, rim. Coarse.	Fortification, Tower B2, 1974	-
VEL-C-2	RVGK01	M1/18	57/90-30	Jug, rim. Coarse, rim: mat finished brownish red slip	Lower Town; Crossroad	B 2
VEL-C-2	RVGK01 d	M1/23	-	Jug, rim. Coarse. rim: brownish black slip, neck exterior: brownish red waveband	Fortifications, tower B2	-
VEL-C-2		M3/65	20/87-2	Jug, rim. Coarse, rim slipped red Gassner 2003, lb.27, pl. 6	Insula II, Late Archaic mud brick houses	B 1
VEL-C-3	RVGK01 d	M3/66	21/90	Body fragment. Coarse.	Lower Town; Crossroad	B 2
VEL-C-3	RVGK01	M3/14	25/90-35	Chytra, short projecting rim. Coarse.	Lower Town; Crossroad	B 3
VEL-C-3	RVGK01 d	M1/8	26/90	Amphora, body fragment. Coarse, exterior: red shining stripe.	Lower Town; Crossroad	B 2
VEL-C-3	RVGK01 d	M1/11	27/90	Amphora, rim. Coarse. Exterior: matt red stripe, rim interior: brownish stripe.	Lower Town; Crossroad	B 2
VEL-C-3	RVGK01 d	M1/15	36/90	Closed vessel, body fragment. Coarse, exterior: gray stripes.	Lower Town; Crossroad	-
VEL-C-3	RVGK01 d1	M1/19	27/90	Jug, rim in- and exterior: black stripe.	Lower Town; Crossroad	B 2
VEL-C-3	RVGK01 d2	M1/20	27/90	Jug, handle. Coarse, exterior: black stripe.	Lower Town; Crossroad	B 2
VEL-C-3	RVGK01 d	M1/22	27/90	Jug, base. Coarse, exterior: red stripe.	Lower Town; Crossroad	B 2
VEL-C-4	RVGK01 d3	M3/30	18/90-69	Bowl, flat rim, upper side of rim: concentric grooves. Coarse, yellowish red	Lower Town; Crossroad	B 3
VEL-C-4	RVGK01 c	M3/13	18/90-56	Chytra, short flat rim. Coarse.	Lower Town; Crossroad	B 3
VEL-C-4	RVGK01	M3/15	21/90-22	Pot, rim. Coarse	Lower Town; Crossroad	B 2
VEL-C-4	RVGK01 a	M3/27	23a/90-40	Dish, rim. Coarse	Lower Town; Crossroad	B 3

VEL-C-4	RVGK01 a	M3/28	27/90-39	Dish, rim. Coarse	Lower Town; Crossroad	B 2
VEL-C-4	RVGK01 a	M3/73	501/91	Closed Vessel, body fragment, coarse.	Insula II, Late Archaic mud brick houses	B 1
VEL-C-4	RVGK01	M3/78	292/91	Body fragment, coarse.	Insula II, Late Archaic mud brick houses	B 1
VEL-C-4	RVGK01 c	M3/79	238/91	Jug, body fragment. Coarse.	Insula II, Late Archaic mud brick houses	B 1
VEL-C-4	RVGK01 d3	M3/89	230/91	Closed vessel, body fragment. Coarse.	Insula II, Late Archaic mud brick houses	B 1
VEL-C-5	RVGK01	M3/99	531/97-39	Jug, rim. Coarse.	Fortification. Wall B	B 1
VEL-C-5	RVGK01	M3/101	511/97-39	Pot, rim. Coarse.	Fortification. Wall B, Trench 5/97	B 1
VEL-C-5	RVGK01	M3/102	502/97-20	Lid, rim. Coarse.	Fortification. Wall B	B 1
VEL-C-6	RVGK01	M3/96	17/87	Body fragment. Coarse.	Insula II, Late Archaic mud brick houses	B 1
VEL-C-6	RVGK01	M3/94	531/97-50	Chytra, rim. Coarse, rim: fire darkened	Fortification. Wall B	B 1
VEL-C-6	RVGK01	M3/97	515/97-5	Lid, rim. Coarse.	Fortification. Wall B	B 1
VEL-C-6	RVGK01	M3/81	504/91	Body fragment. Coarse.	Insula II, Late Archaic mud brick houses	B 1
VEL-C-7		M3/103	522/1/98- 19	Bowl, ring foot. Smoothed, light red	Fortifications, wall B	E
VEL-C-8		M3/105	520/4/98- 54	Lid, button. Smoothed. light red	Fortifications, wall B	E
VEL-C-9		M3/106	520/4/98- 26	Chytra, short projecting rim. Coarse.	Fortifications, wall B	E
VEL-C- 10		M3/107	531/2/98 - 124	Shallow cooking pot, horizontal projecting rim. Coarse. Reddish yellow, exterior: fire darkened.	Fortifications, wall B	E
VEL-C- 11		M3/104	525/3/98- 81	Pan, rim. Coarse. Interior: light reddish brown, exterior: fire darkened. Rim diameter: 20 cm	Fortifications, wall B	E

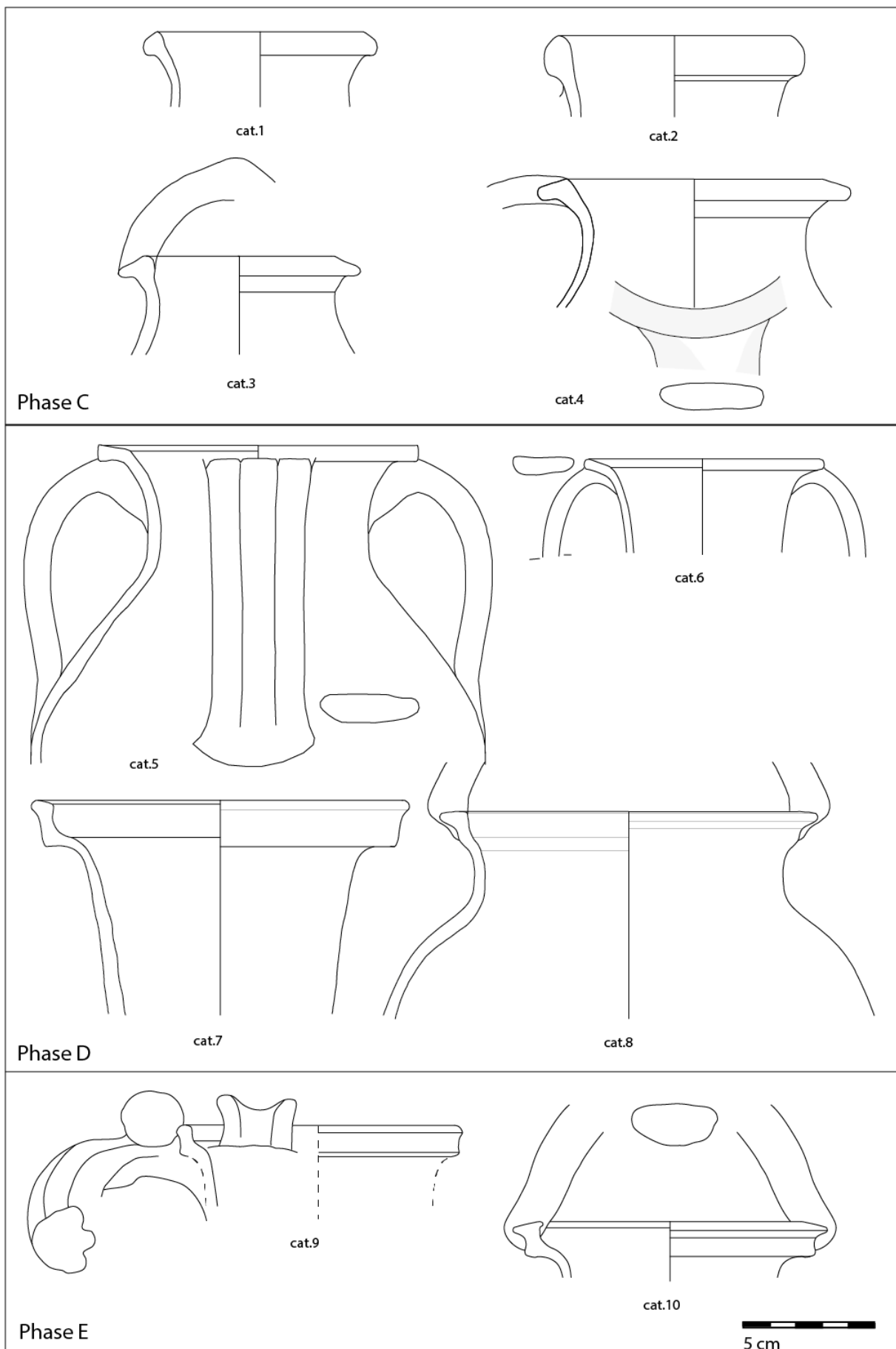

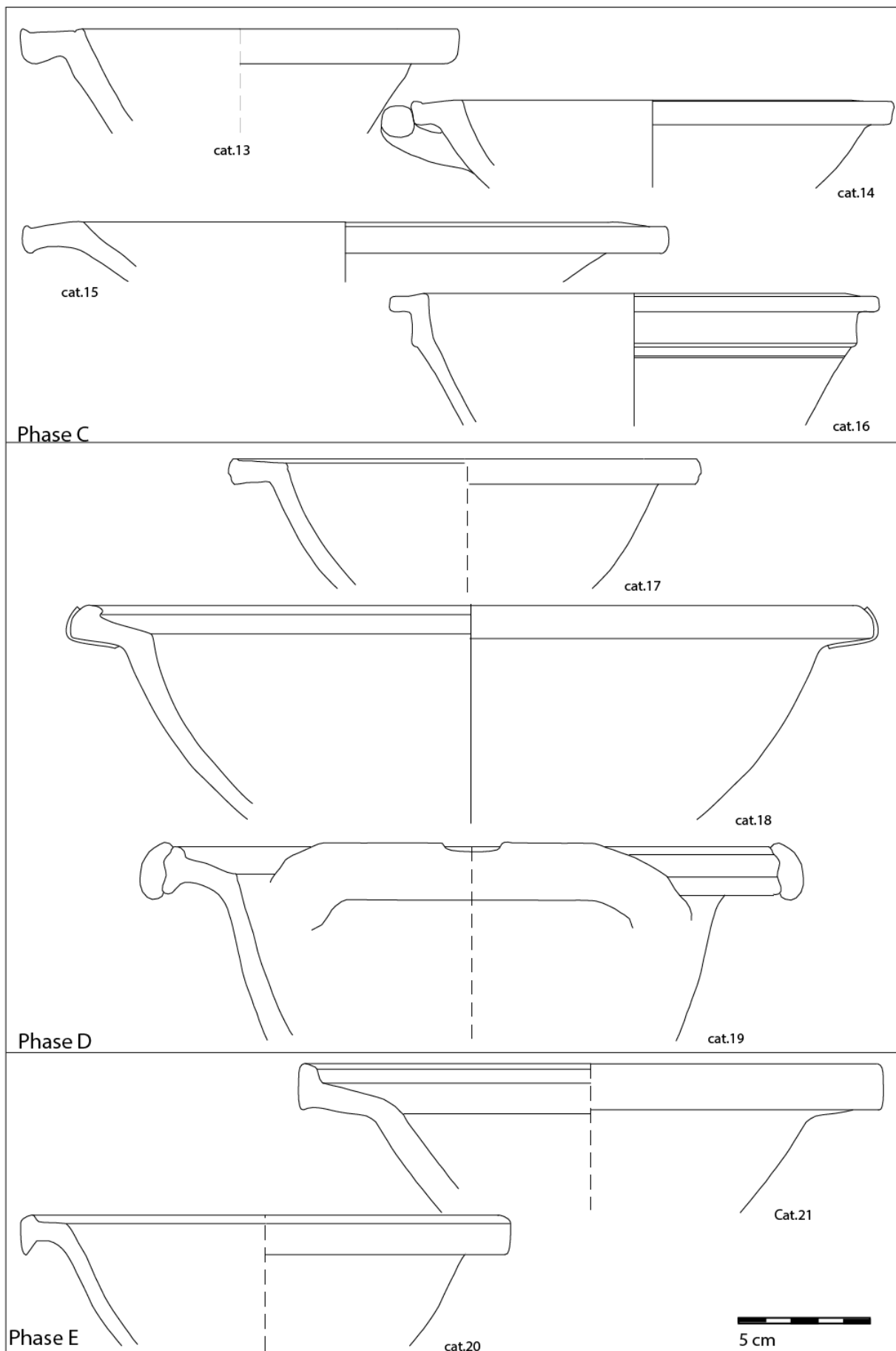

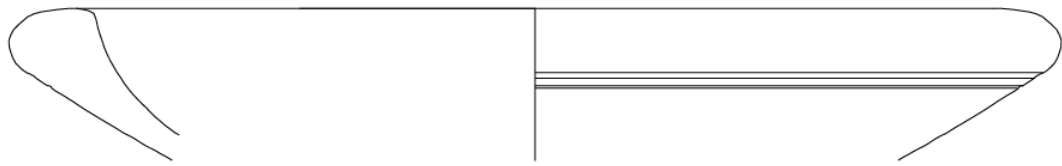

cat.22

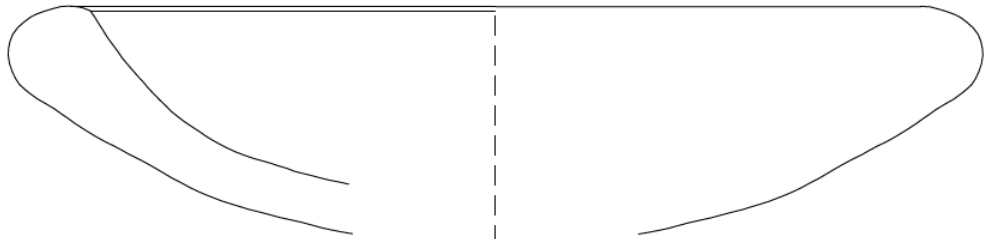

cat.23

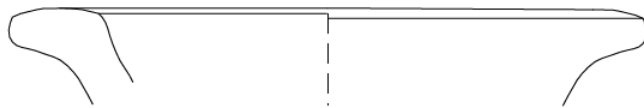

cat.24

Phase C

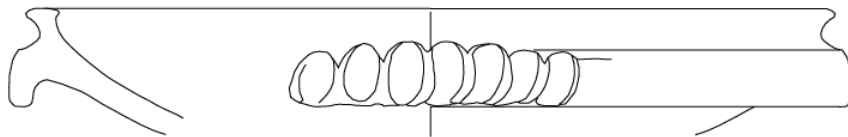

cat.25

Phase D

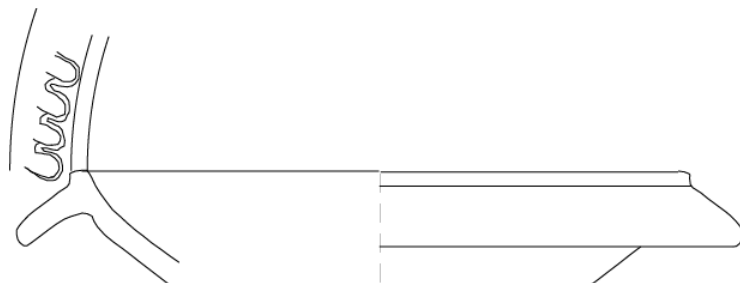

cat.26

Phase E



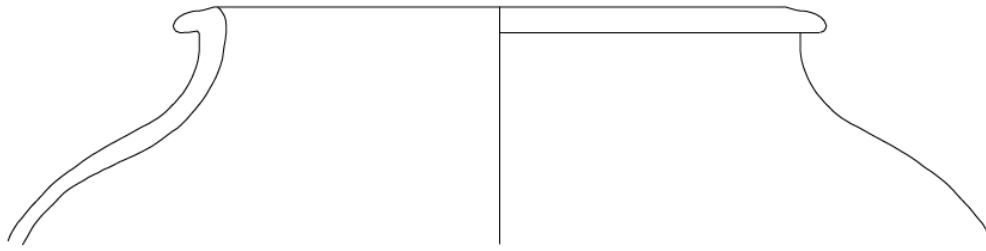

Phase C

cat.27

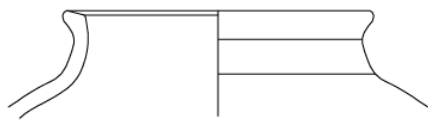

cat.28

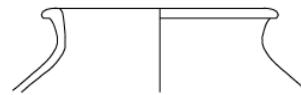

cat.29

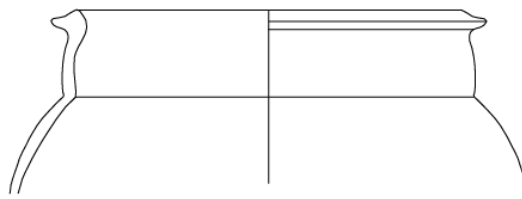

Phase D

cat.30

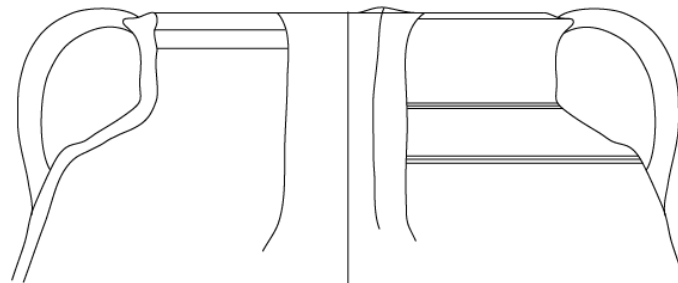

cat.31

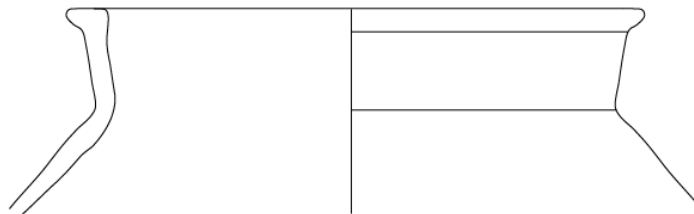

cat.32

Phase E

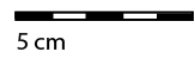

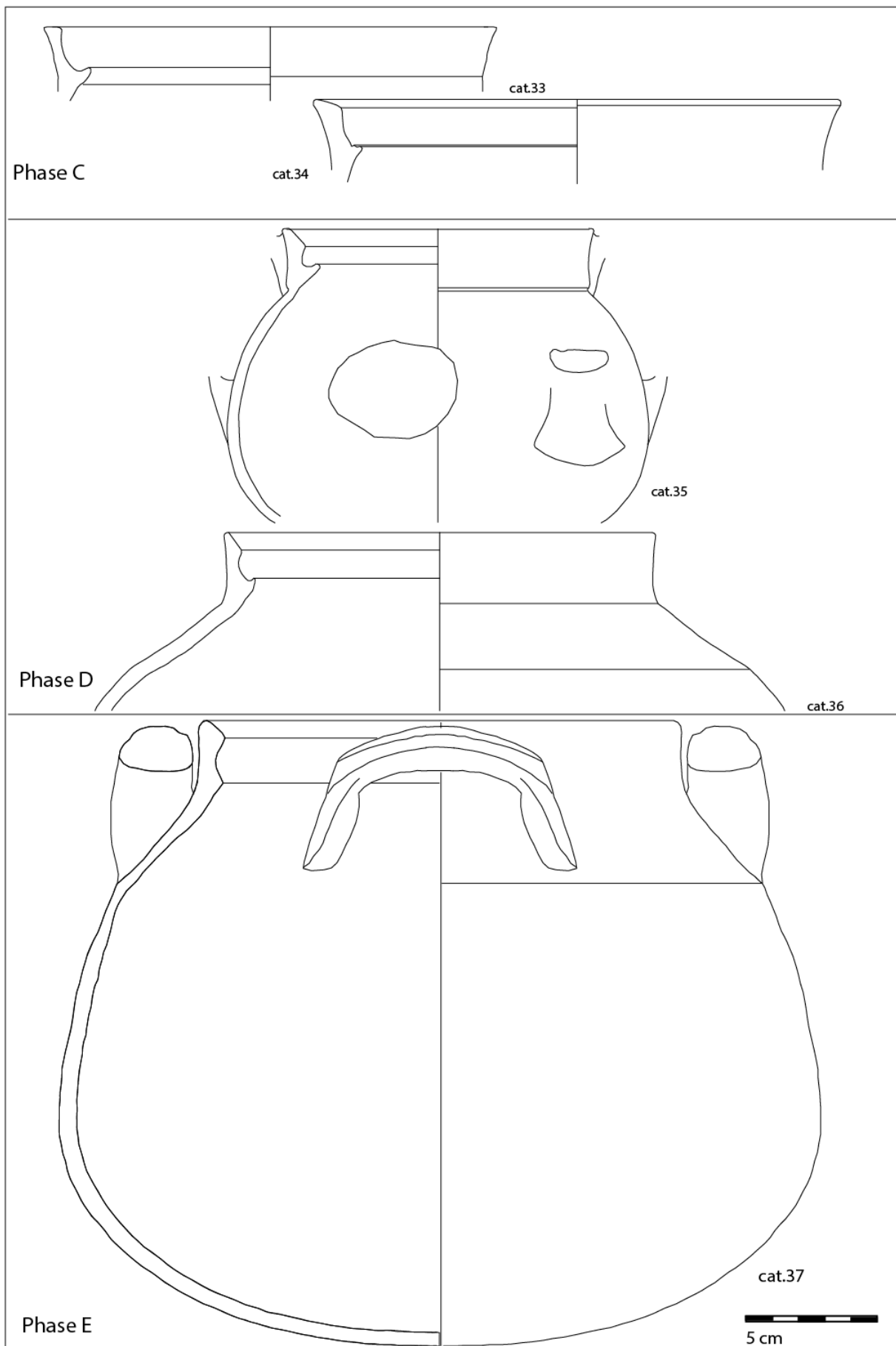

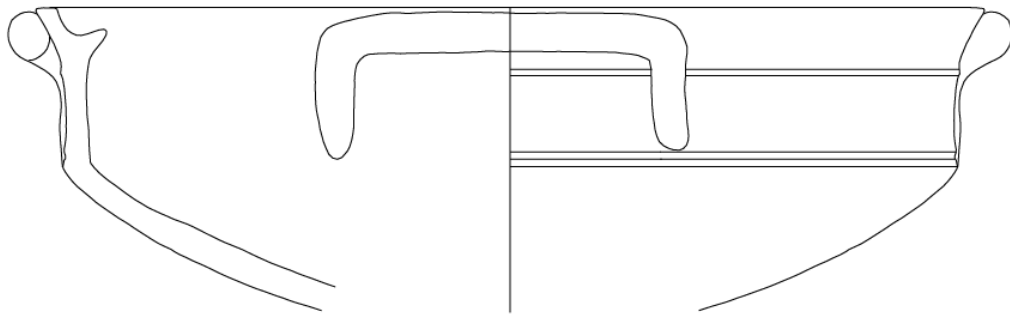

cat.38

Phase C

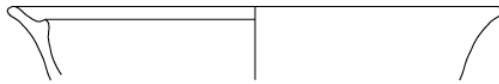

cat.39



cat. 40

Phase D

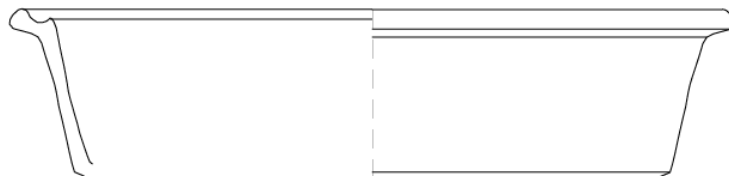

cat.41

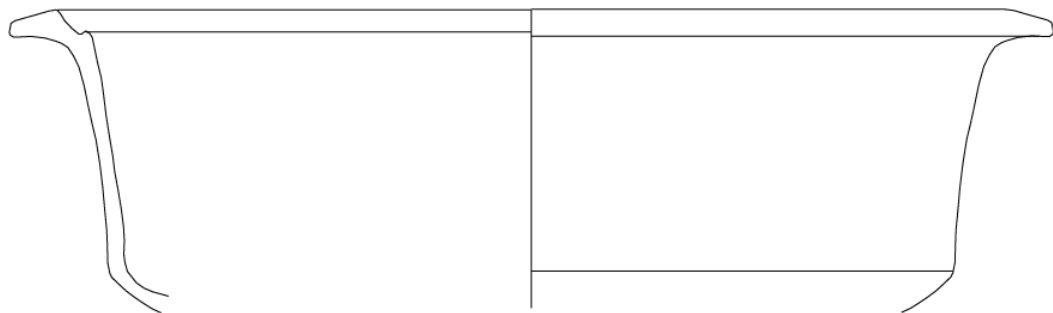

cat.42

Phase E



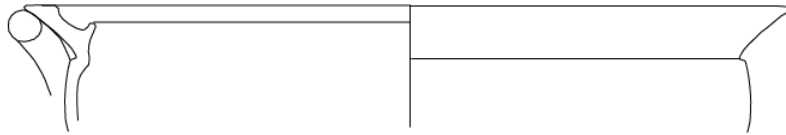

cat.43

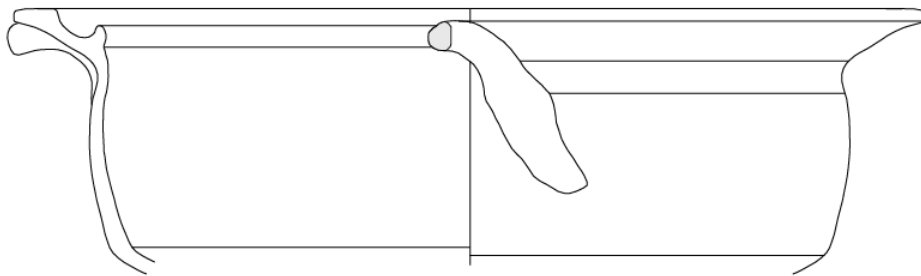

cat.44

Phase D

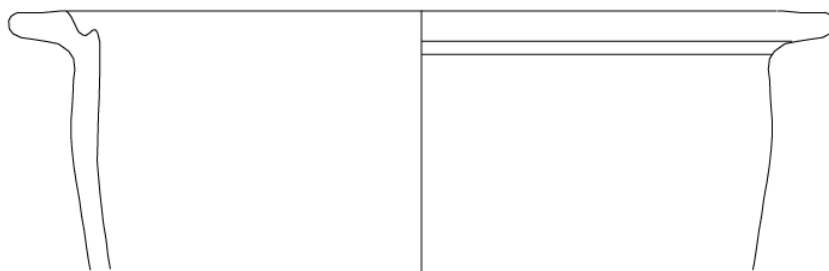

cat.45

Phase E



5 cm

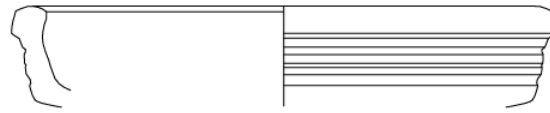

cat.46

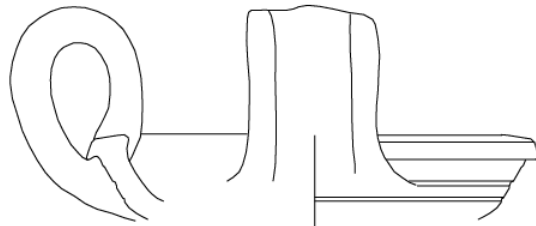

cat.47

Phase C

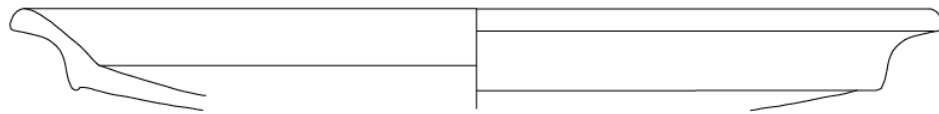

cat.48

Phase D



cat.49

Phase E

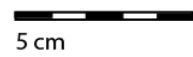

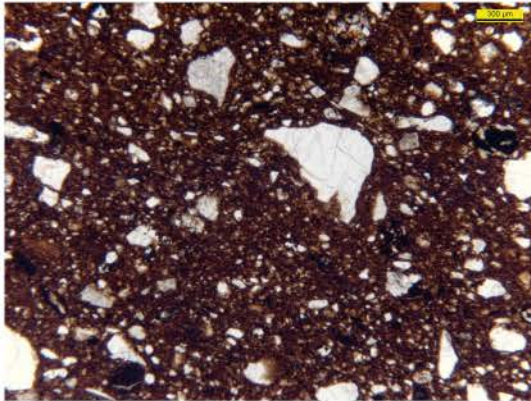

RVGK01
VEL-C-2
M3/64 + M3/65
thin section overview; //pol

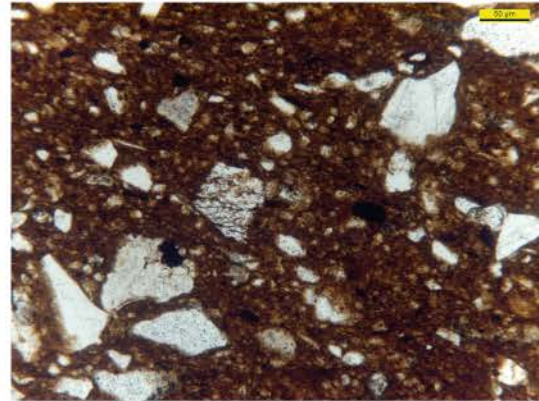

RVGK01
VEL-C-2
M3/64 + M3/65
thin section overview; //pol

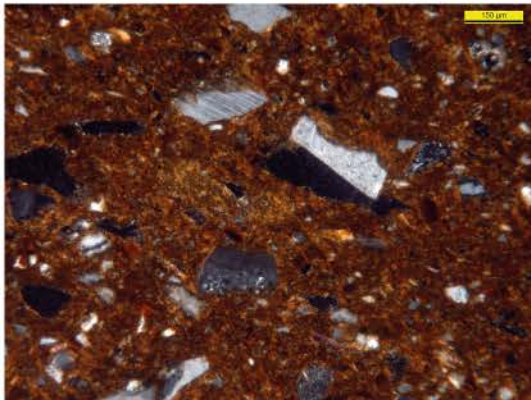

RVGK01
VEL-C-2
M3/64 + M3/65
thin section overview; #pol

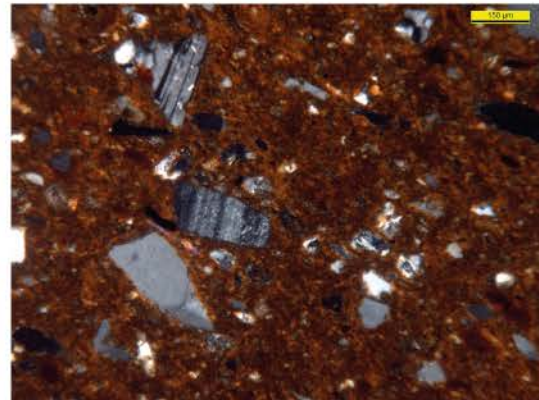

RVGK01
VEL-C-2
M3/64 + M3/65
thin section overview; #pol

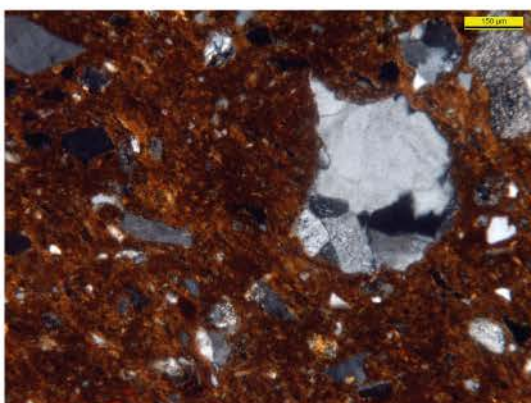

RVGK01
VEL-C-2
M3/64 + M3/65
thin section overview; #pol

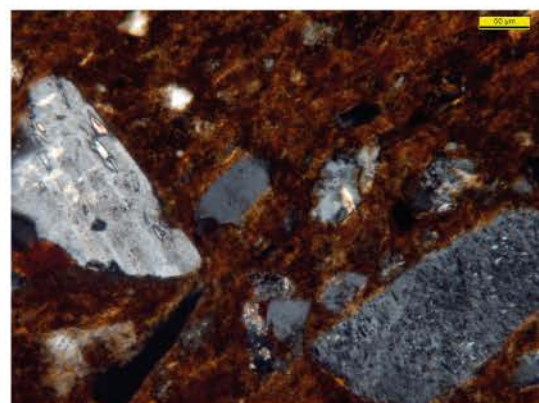

RVGK01
VEL-C-2
M3/64 + M3/65
thin section overview; #pol

Pl. 10

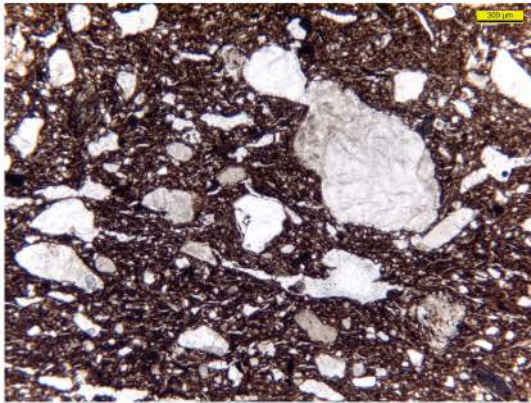

RVGK01h
VEL-C-4
M3/30
thin section overview; //pol

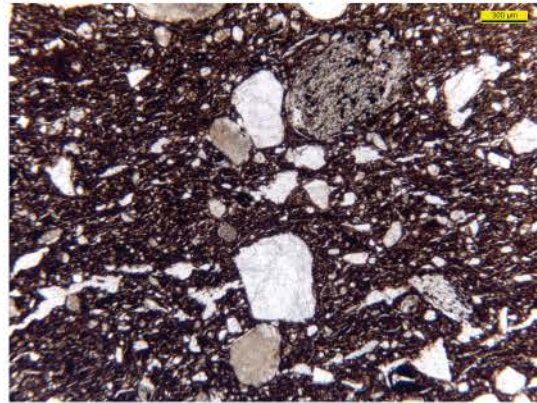

RVGK01h
VEL-C-4
M3/30
thin section overview; //pol

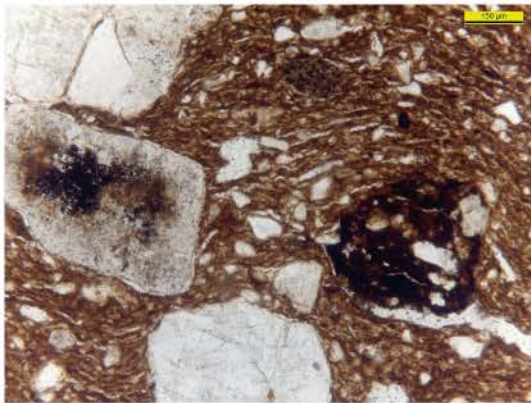

RVGK01h
VEL-C-4
M3/30
thin section overview; //pol

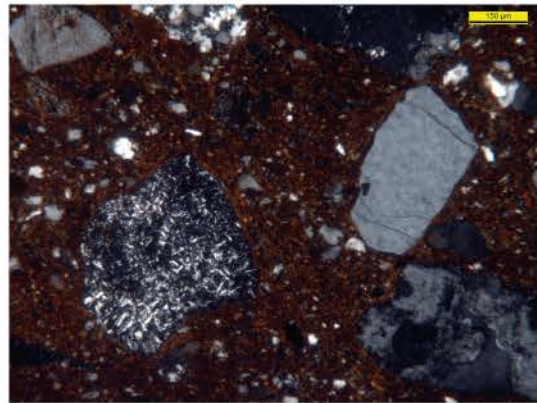

RVGK01h
VEL-C-4
M3/30
thin section overview; #pol

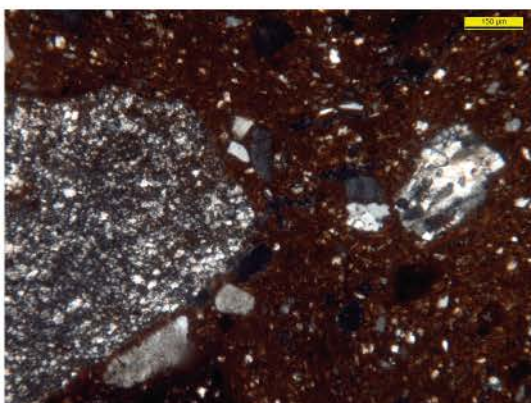

RVGK01h
VEL-C-4
M3/30
thin section overview; #pol

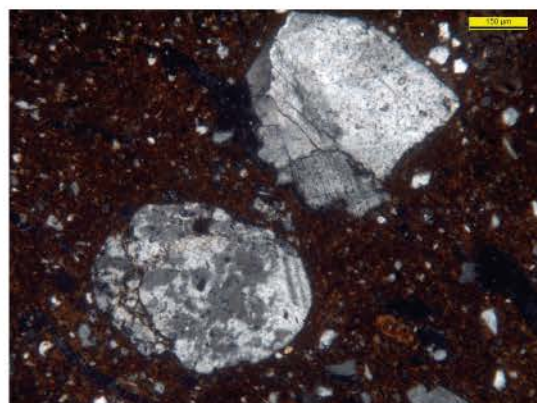

RVGK01h
VEL-C-4
M3/30
thin section overview; #pol

Pl. 11

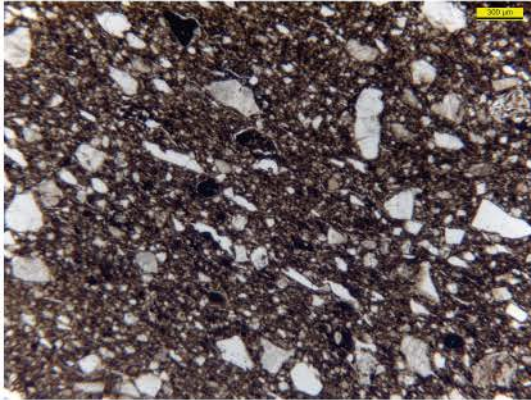

RVGK01h
VEL-C-10
M3/107
thin section overview; //pol

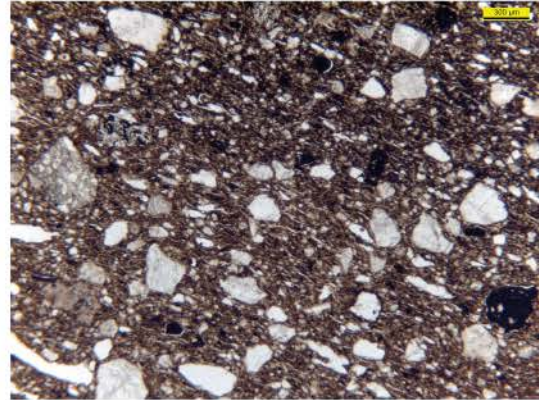

RVGK01h
VEL-C-10
M3/107
thin section overview; //pol

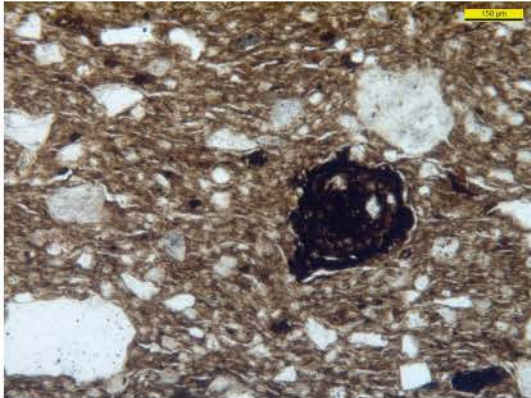

RVGK01h
VEL-C-10
M3/107
thin section overview; //pol

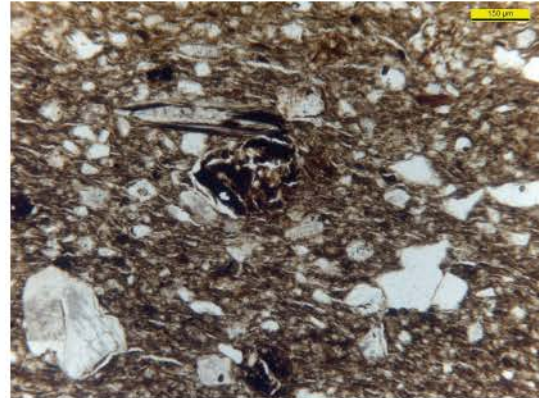

RVGK01h
VEL-C-10
M3/107
thin section overview; //pol

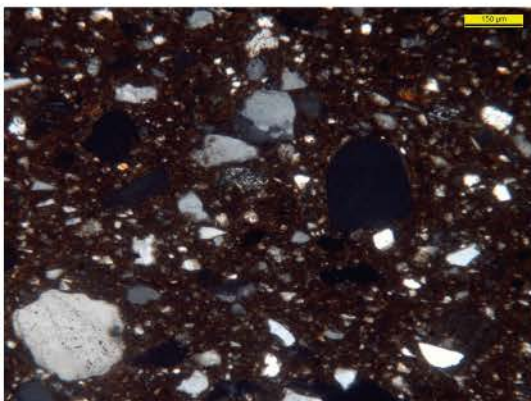

RVGK01h
VEL-C-10
M3/107
thin section overview; #pol

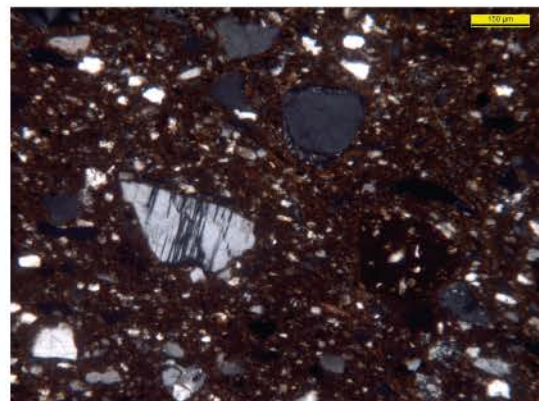

RVGK01h
VEL-C-10
M3/107
thin section overview; #pol

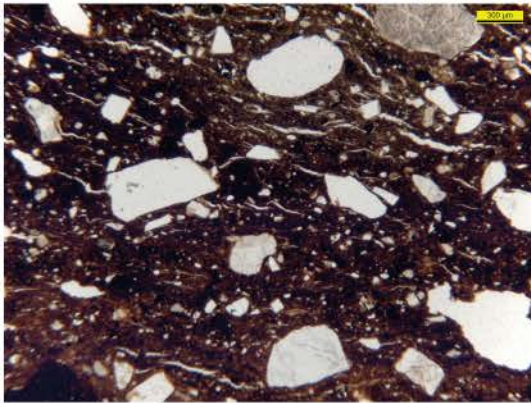

RVGK01a
VEL-C-6
M3/96
thin section overview; //pol

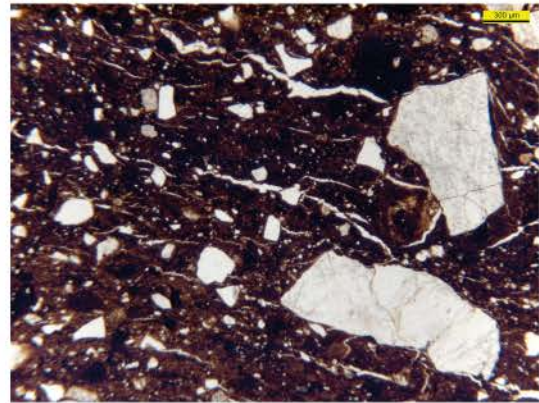

RVGK01a
VEL-C-6
M3/96
thin section overview; //pol

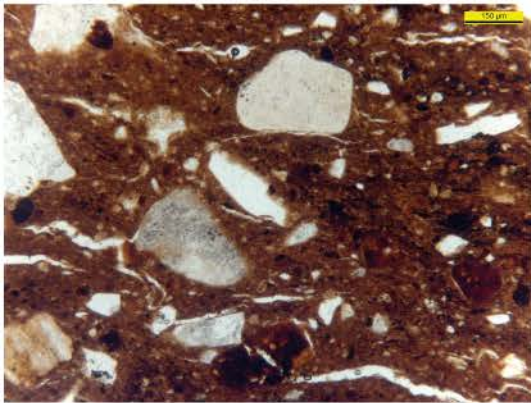

RVGK01a
VEL-C-6
M3/96
thin section overview; #pol

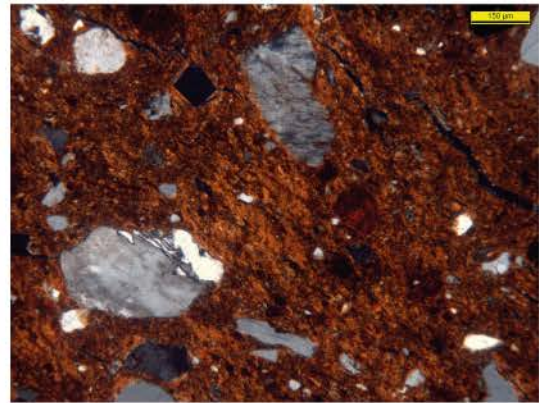

RVGK01a
VEL-C-6
M3/96
thin section overview; #pol

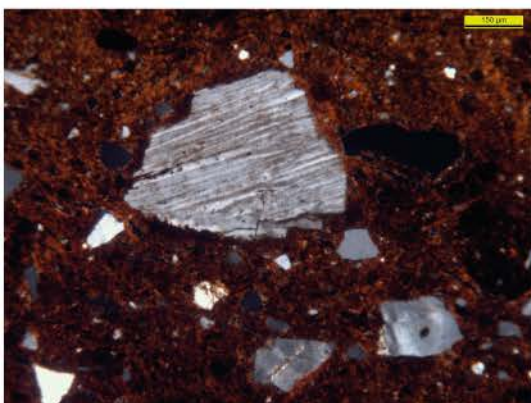

RVGK01a
VEL-C-6
M3/96
thin section overview; #pol

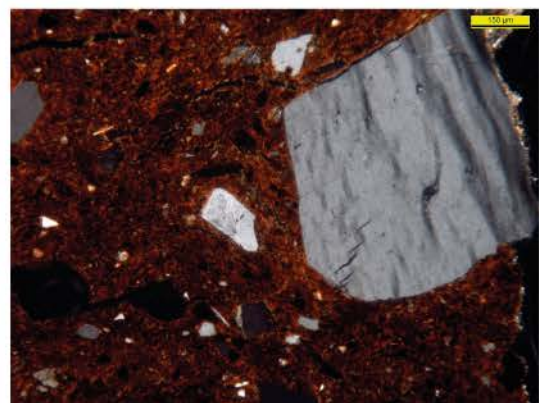

RVGK01a
VEL-C-6
M3/96
thin section overview; #pol

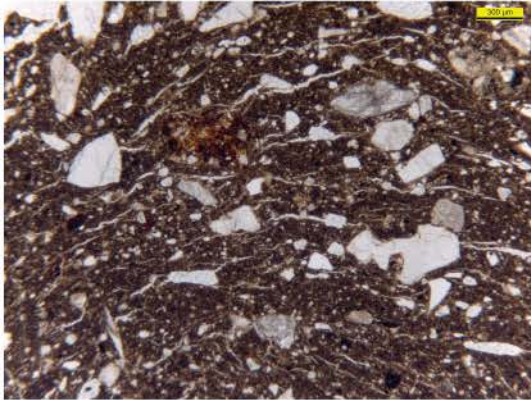

RVGK01a
VEL-C-5
M3/99
thin section overview; //pol

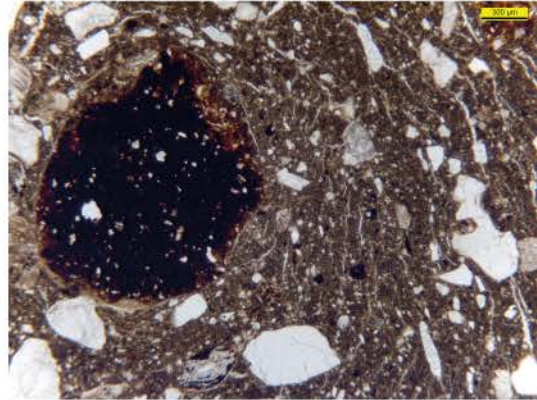

RVGK01a
VEL-C-5
M3/99
thin section overview; //pol

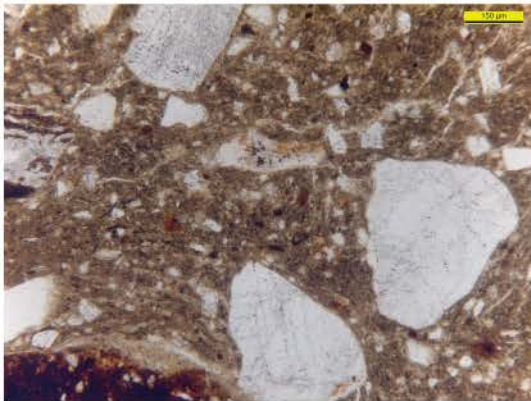

RVGK01a
VEL-C-5
M3/99
thin section overview; //pol

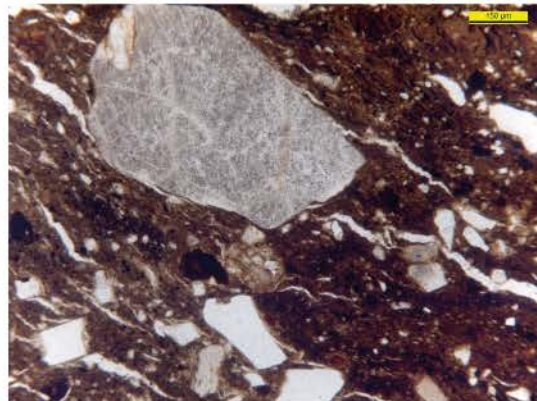

RVGK01a
VEL-C-5
M3/99
thin section overview; //pol

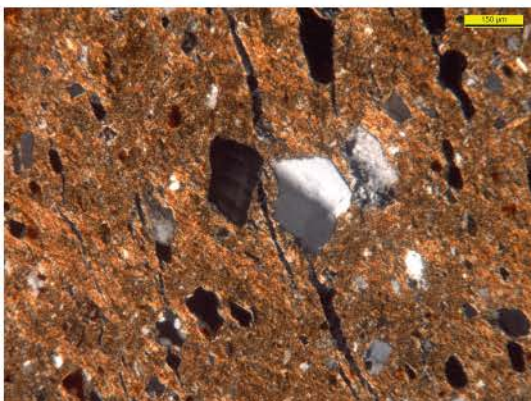

RVGK01a
VEL-C-5
M3/99
thin section overview; //pol

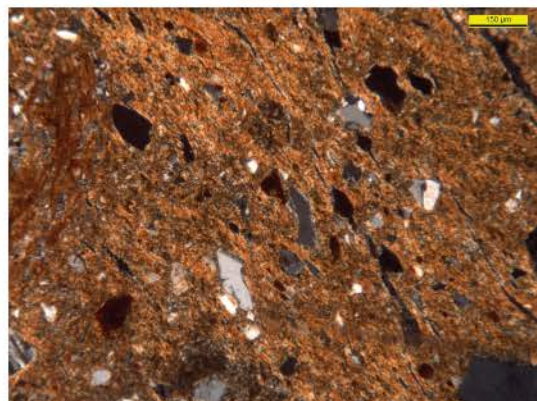

RVGK01a
VEL-C-5
M3/99
thin section overview; //pol

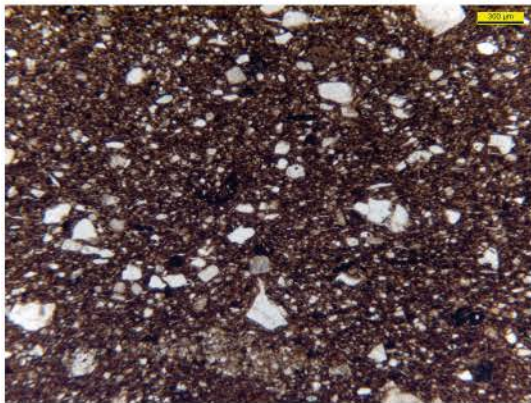

RVGK01c
VEL-C-7
M3/103
thin section overview; //pol

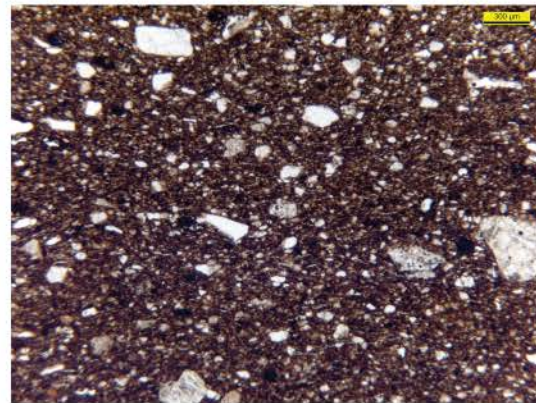

RVGK01c
VEL-C-7
M3/103
thin section overview; //pol

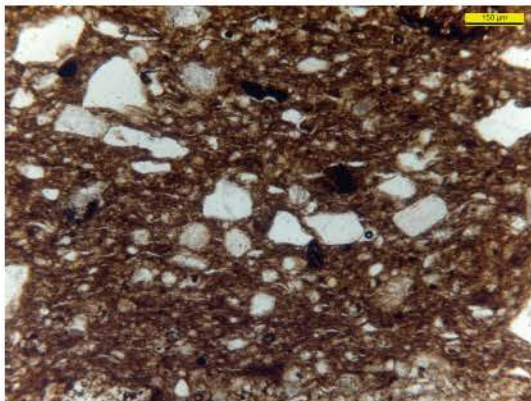

RVGK01c
VEL-C-7
M3/103
thin section overview; //pol

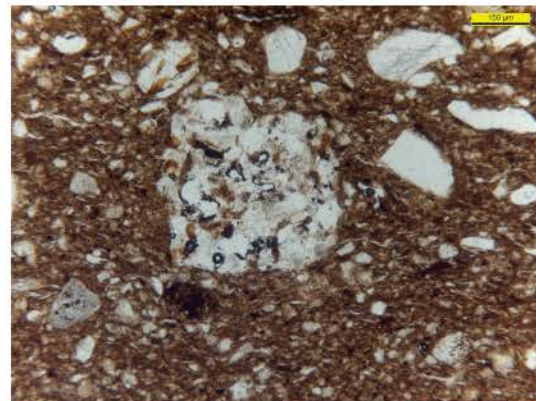

RVGK01c
VEL-C-7
M3/103
thin section overview; //pol

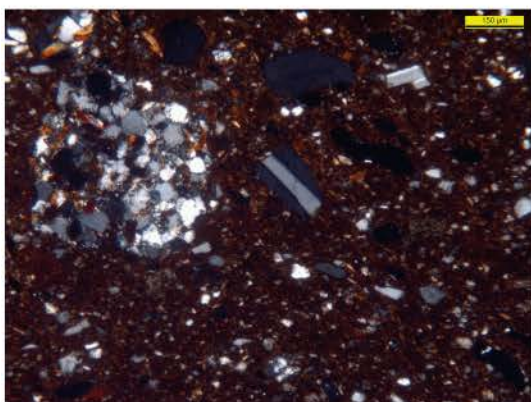

RVGK01c
VEL-C-7
M3/103
thin section overview; #pol

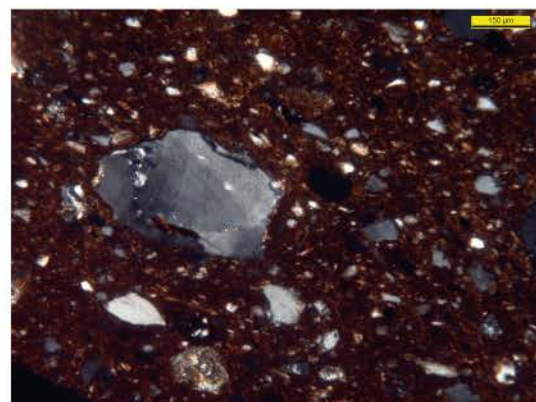

RVGK01c
VEL-C-7
M3/103
thin section overview; #pol

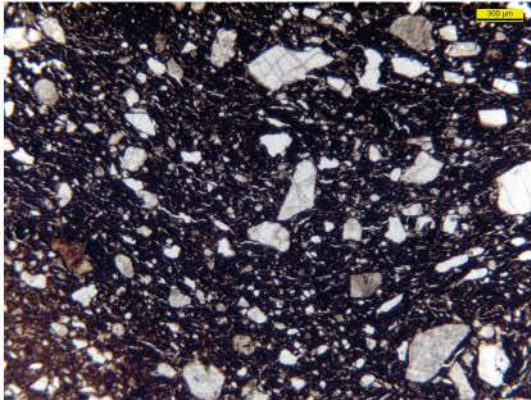

RVGK01c
VEL-C-11
M3/104
thin section overview; //pol

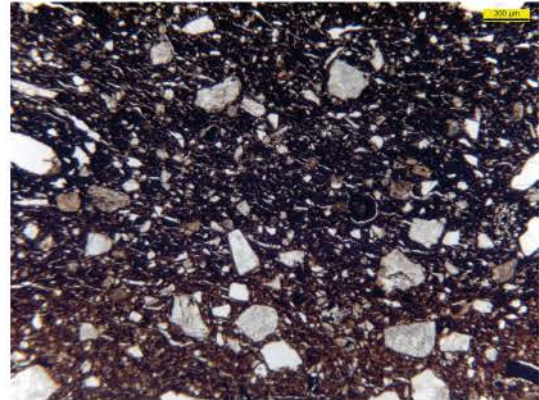

RVGK01c
VEL-C-11
M3/104
thin section overview; //pol

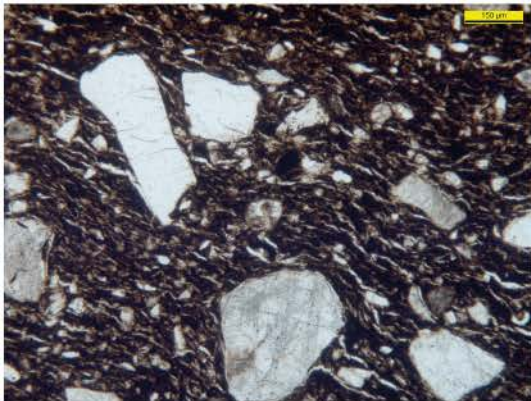

RVGK01c
VEL-C-11
M3/104
thin section overview; //pol

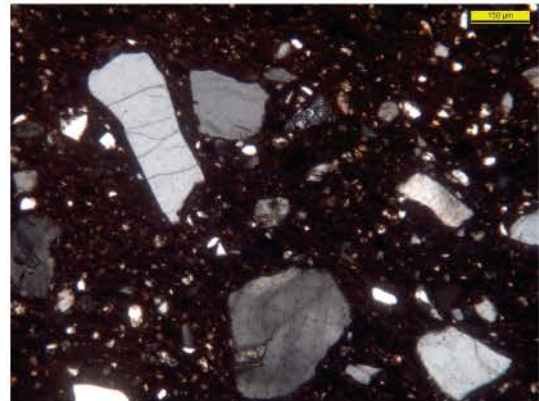

RVGK01c
VEL-C-11
M3/104
thin section overview; #pol

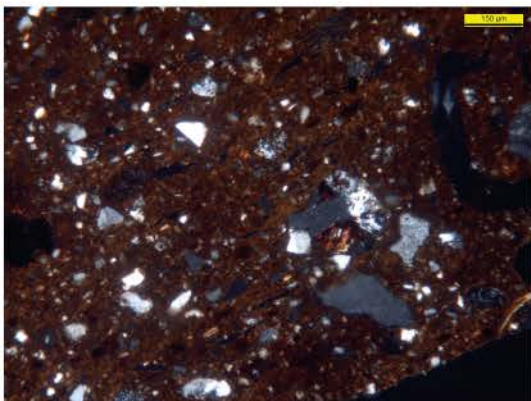

RVGK01c
VEL-C-11
M3/104
thin section overview; #pol

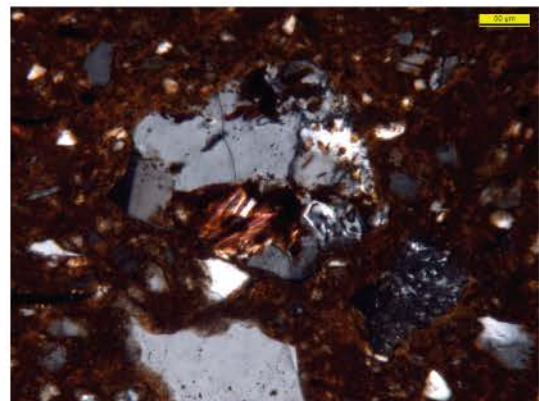

RVGK01c
VEL-C-11
M3/104
thin section overview; #pol

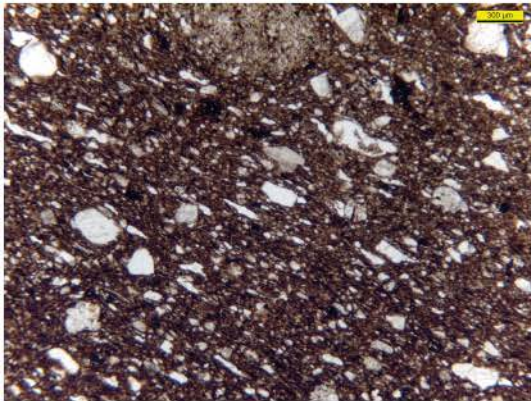

RVGK01c
VEL-C-9
M3/106
thin section overview; //pol

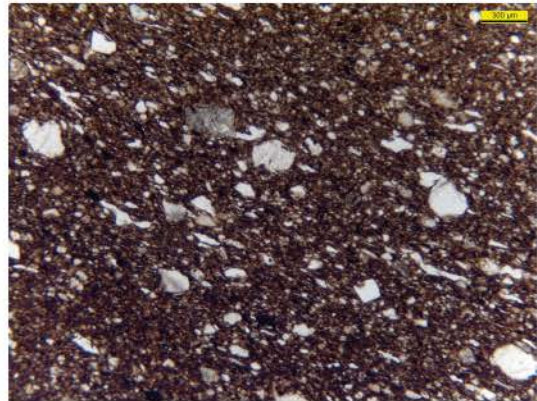

RVGK01c
VEL-C-9
M3/106
thin section overview; //pol

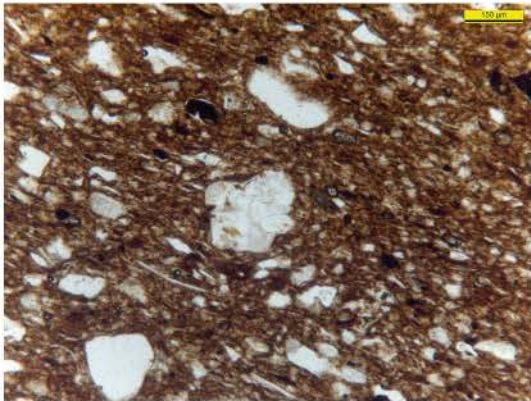

RVGK01c
VEL-C-9
M3/106
thin section overview; //pol

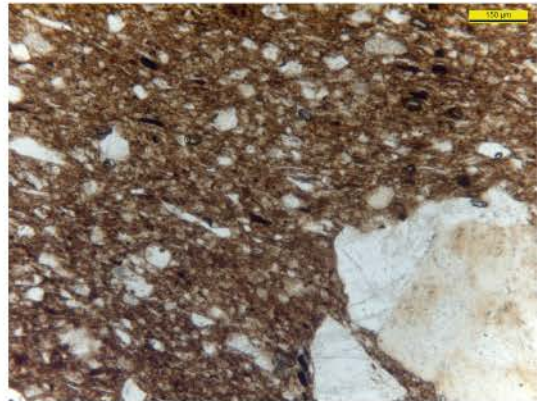

RVGK01c
VEL-C-9
M3/106
thin section overview; //pol

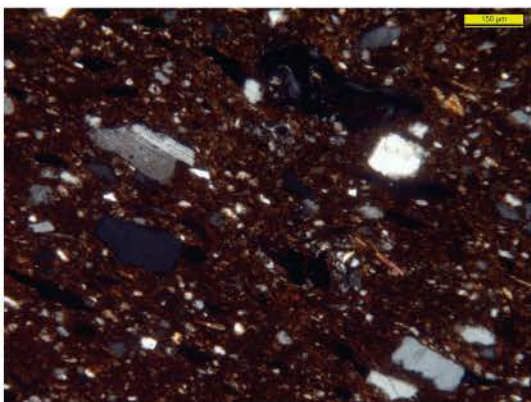

RVGK01c
VEL-C-9
M3/106
thin section overview; #pol

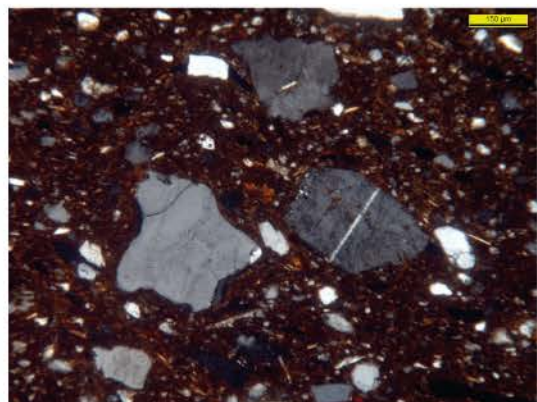

RVGK01c
VEL-C-9
M3/106
thin section overview; #pol

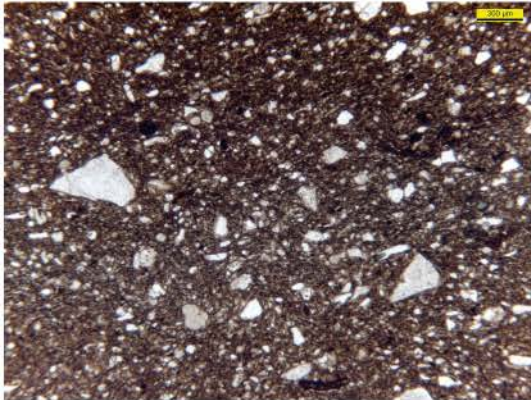

RVGK01d
VEL-C-1
M3/10
thin section overview; //pol

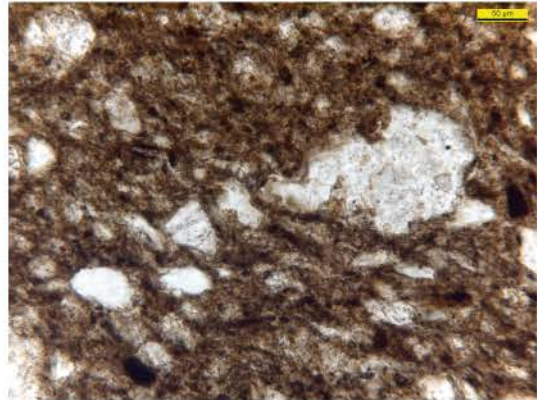

RVGK01d
VEL-C-1
M3/10
thin section overview; //pol

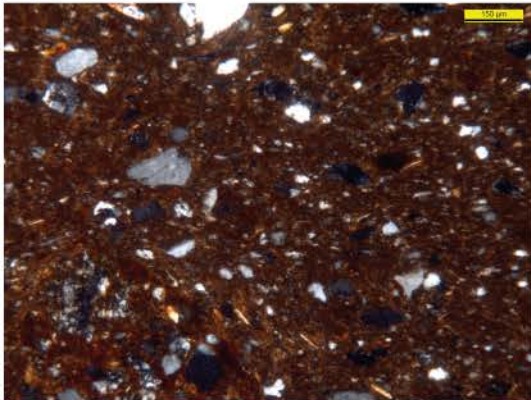

RVGK01d
VEL-C-1
M3/10
thin section overview; #pol

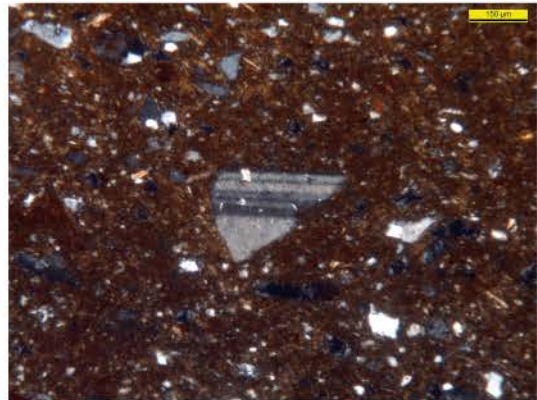

RVGK01d
VEL-C-1
M3/10
thin section overview; #pol

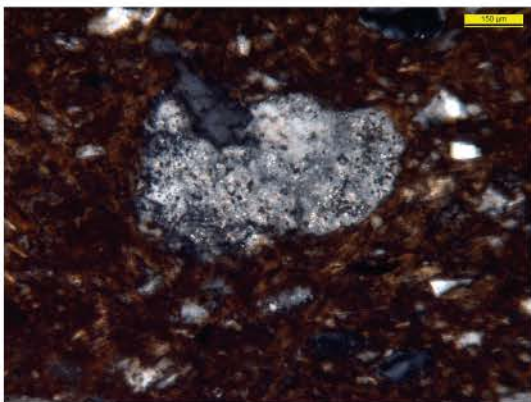

RVGK01d
VEL-C-1
M3/10
thin section overview; #pol

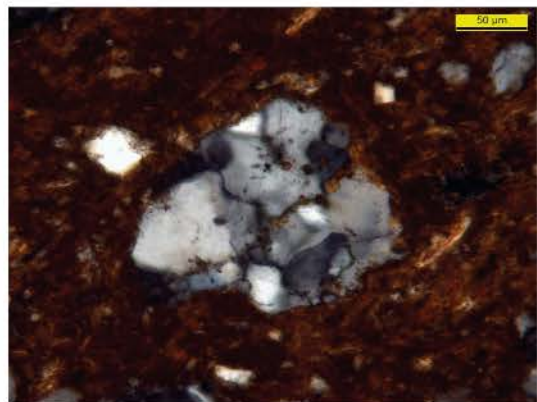

RVGK01d
VEL-C-1
M3/10
thin section overview; #pol

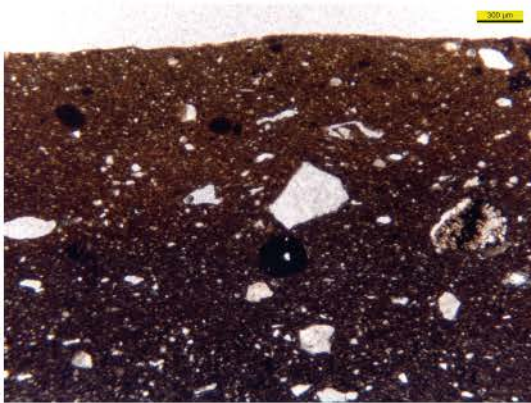

RVGK01d
VEL-C-3
M3/66
thin section overview; //pol

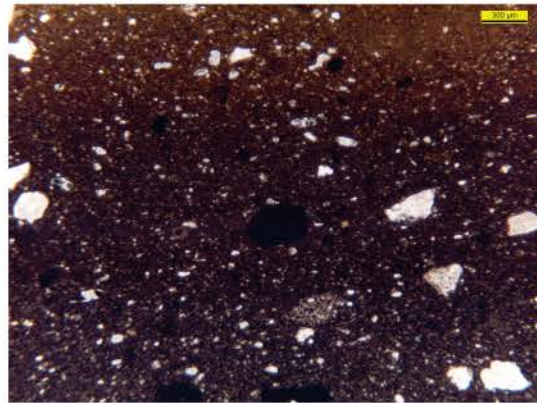

RVGK01d
VEL-C-3
M3/66
thin section overview; //pol

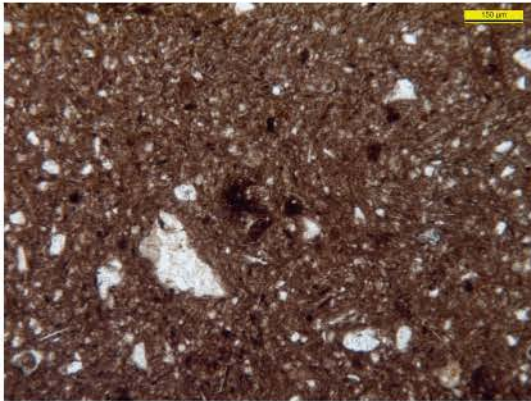

RVGK01d
VEL-C-3
M3/66
thin section overview; //pol

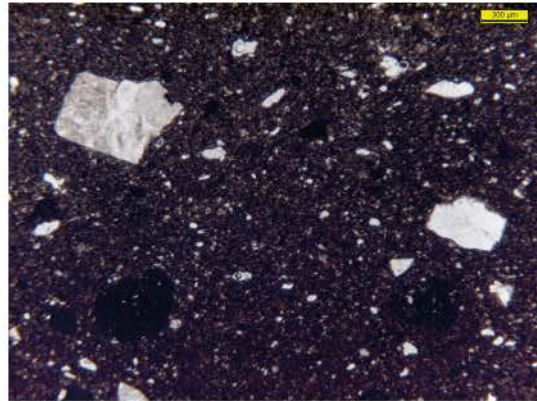

RVGK01d
VEL-C-3
M3/66
thin section overview; //pol

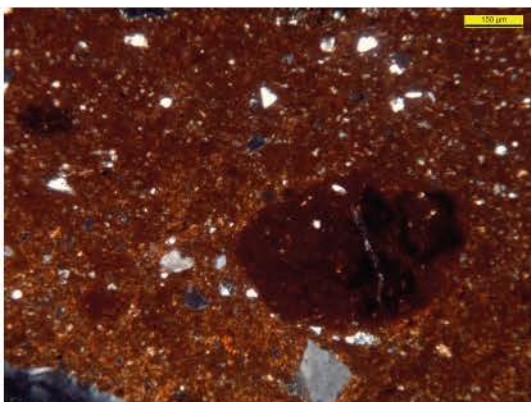

RVGK01d
VEL-C-3
M3/66
thin section overview; //pol

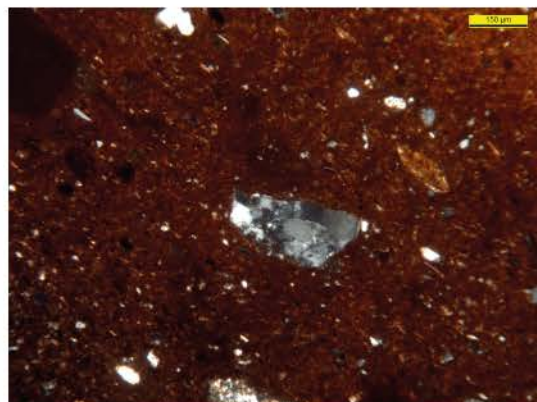

RVGK01d
VEL-C-3
M3/66
thin section overview; //pol

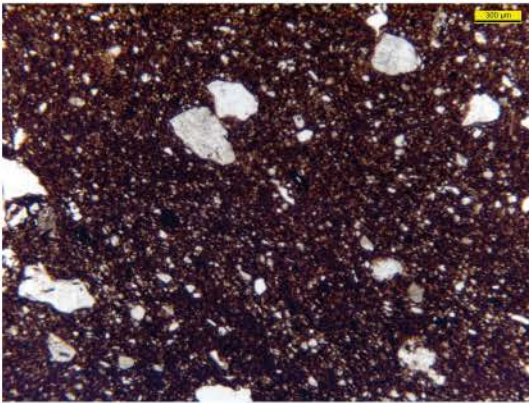

RVGK01d
VEL-C-8
M3/105
thin section overview; //pol

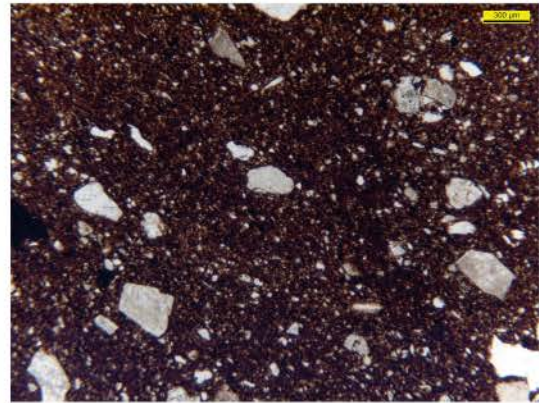

RVGK01d
VEL-C-8
M3/105
thin section overview; //pol

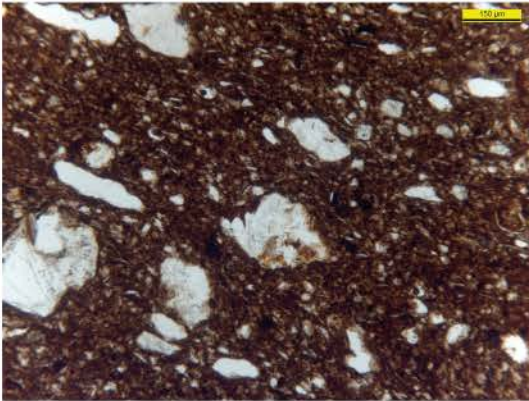

RVGK01d
VEL-C-8
M3/105
thin section overview; //pol

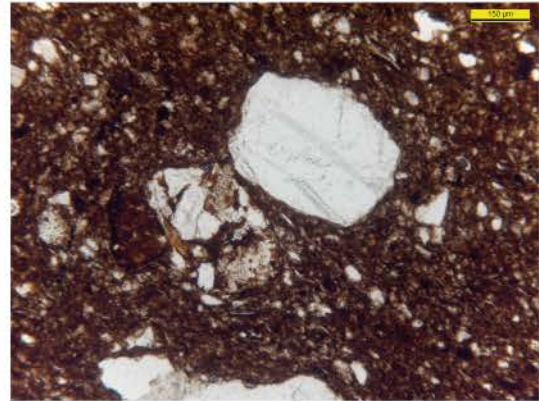

RVGK01d
VEL-C-8
M3/105
thin section overview; //pol

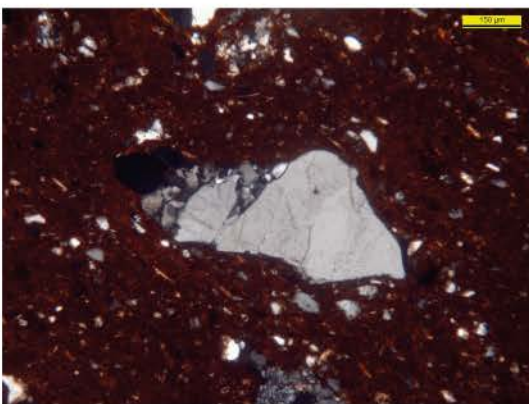

RVGK01d
VEL-C-8
M3/105
thin section overview; #pol

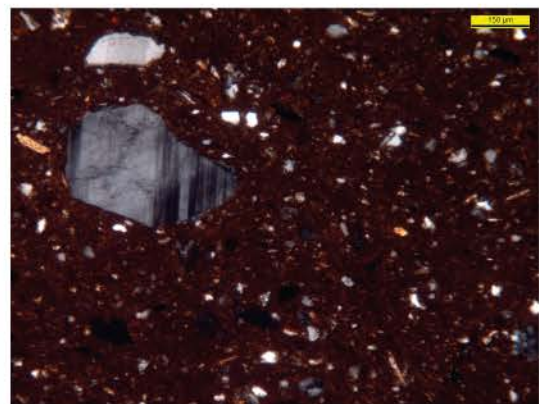

RVGK01d
VEL-C-8
M3/105
thin section overview; #pol